

# 1995 Vulcan 88

## PARTS DIAGRAM

### Clutch

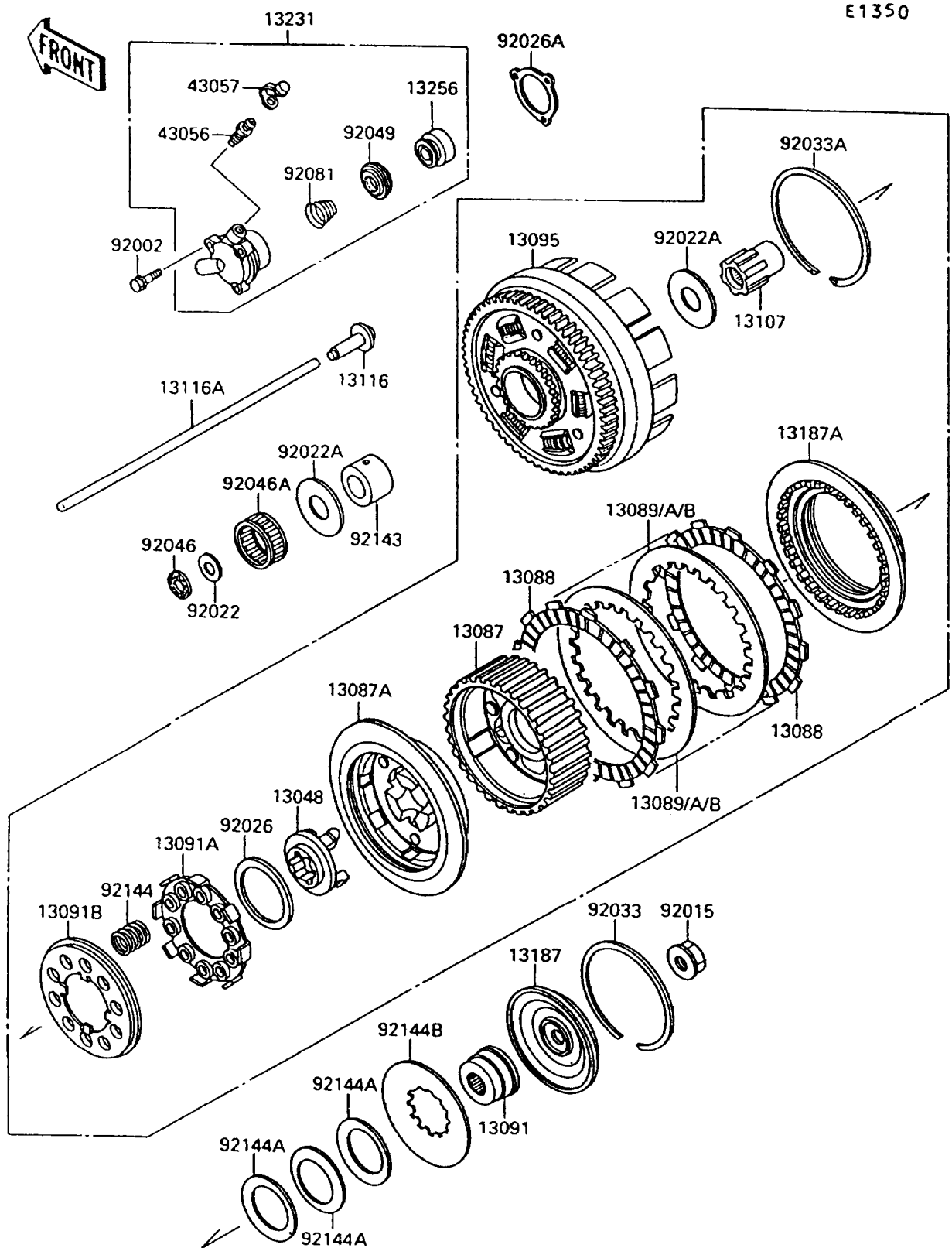

# 1995 Vulcan 88

## PARTS LIST

### Clutch

**ITEM NAME**

**PART NUMBER**

**QUANTITY**

---