

1989 Vulcan 88

PARTS DIAGRAM

Tail Lamp

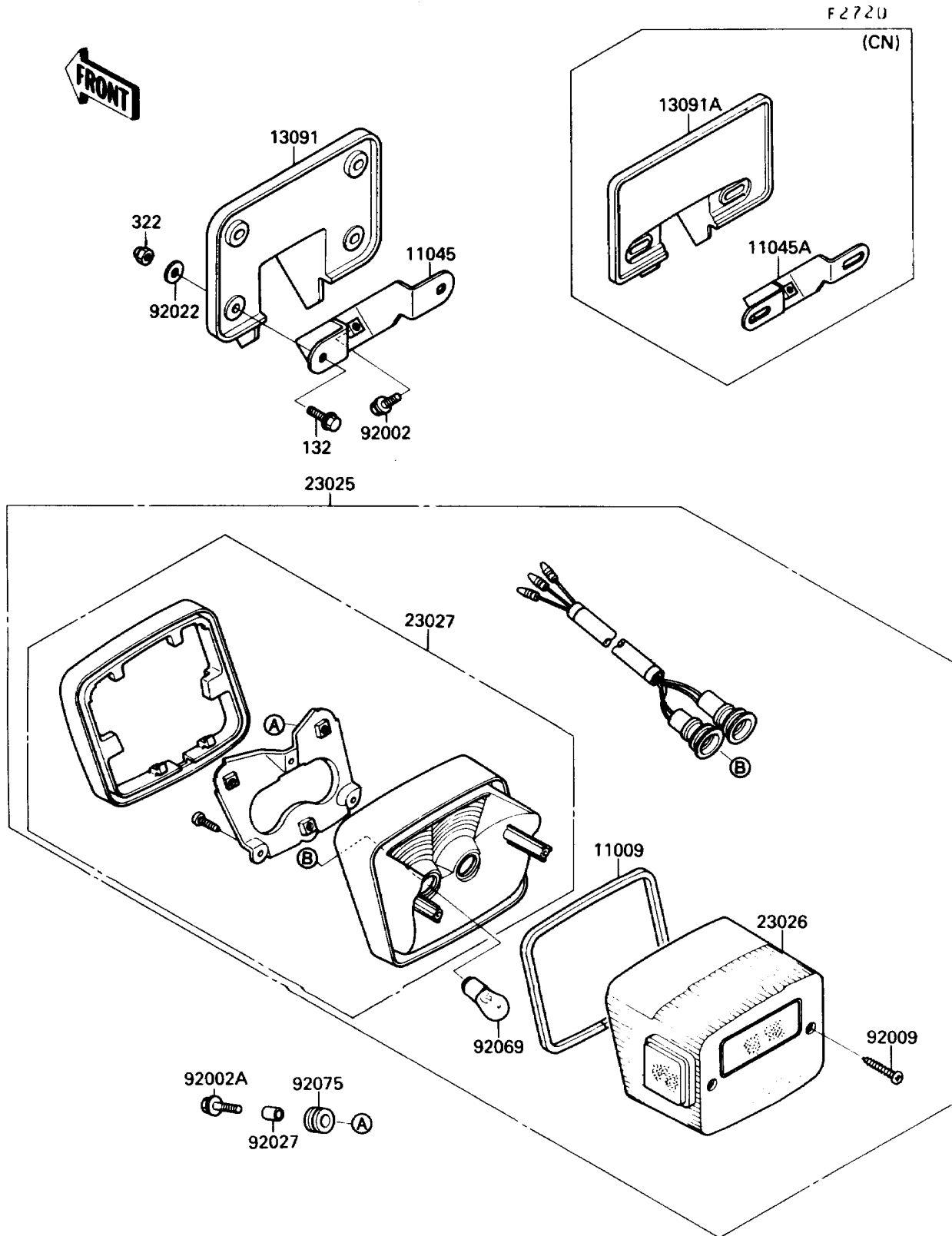

1989 Vulcan 88

PARTS LIST

Tail Lamp

ITEM NAME

PART NUMBER

QUANTITY
