

2019 MULE SX™ 4x4 SE

PARTS DIAGRAM

Optional Parts(Engine)

F2890



(Ref. Drive Converter)

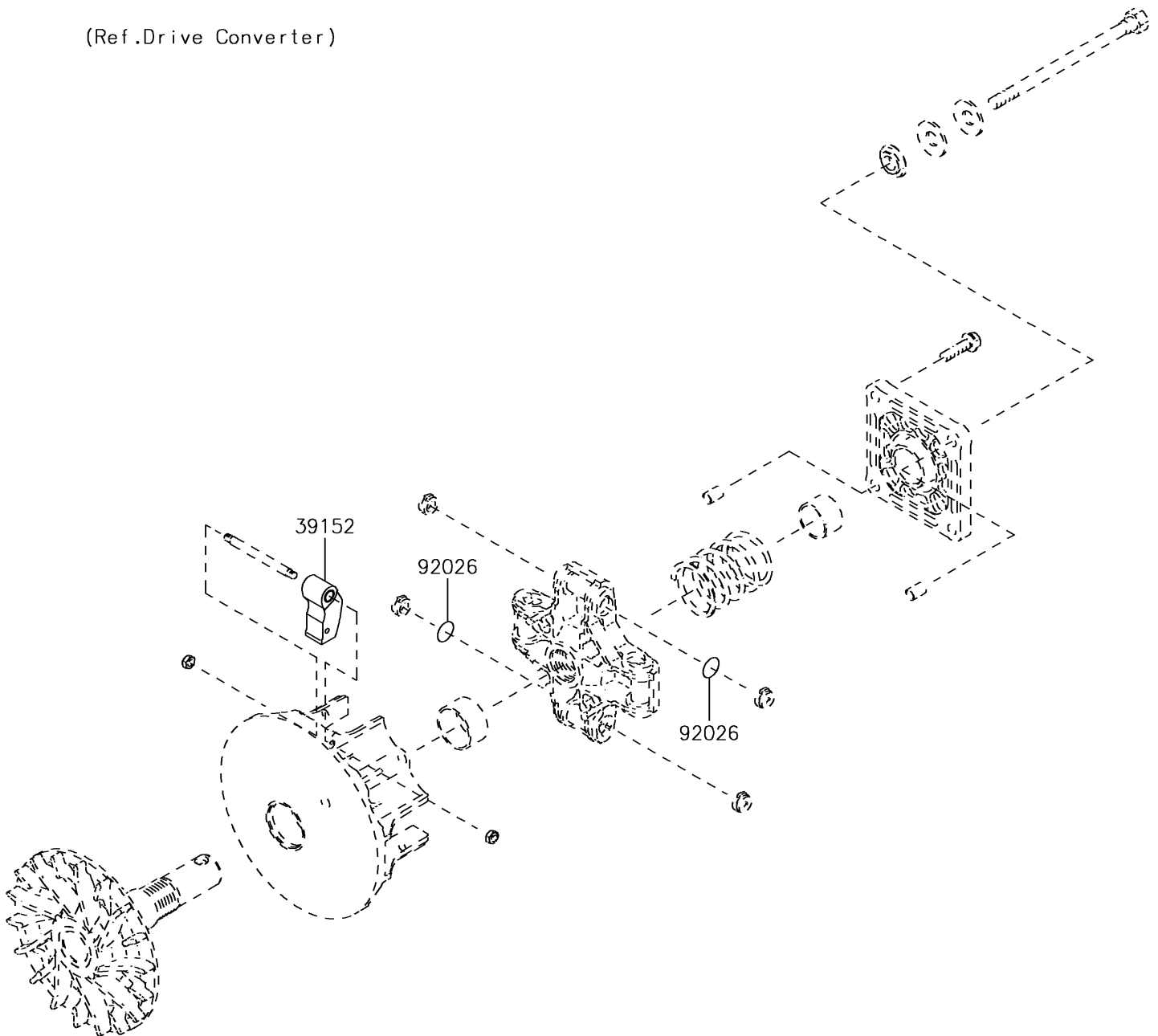

2019 MULE SX™ 4x4 SE

PARTS LIST

Optional Parts(Engine)

ITEM NAME	PART NUMBER	QUANTITY
WEIGHT-RAMP,C155 (Ref # 39152)	39152-0014	4
SPACER,T=0.1 (Ref # 92026)	92026-0038	2