

# 2022 KLX<sup>®</sup>230

## PARTS DIAGRAM

### Frame Fittings

F2131

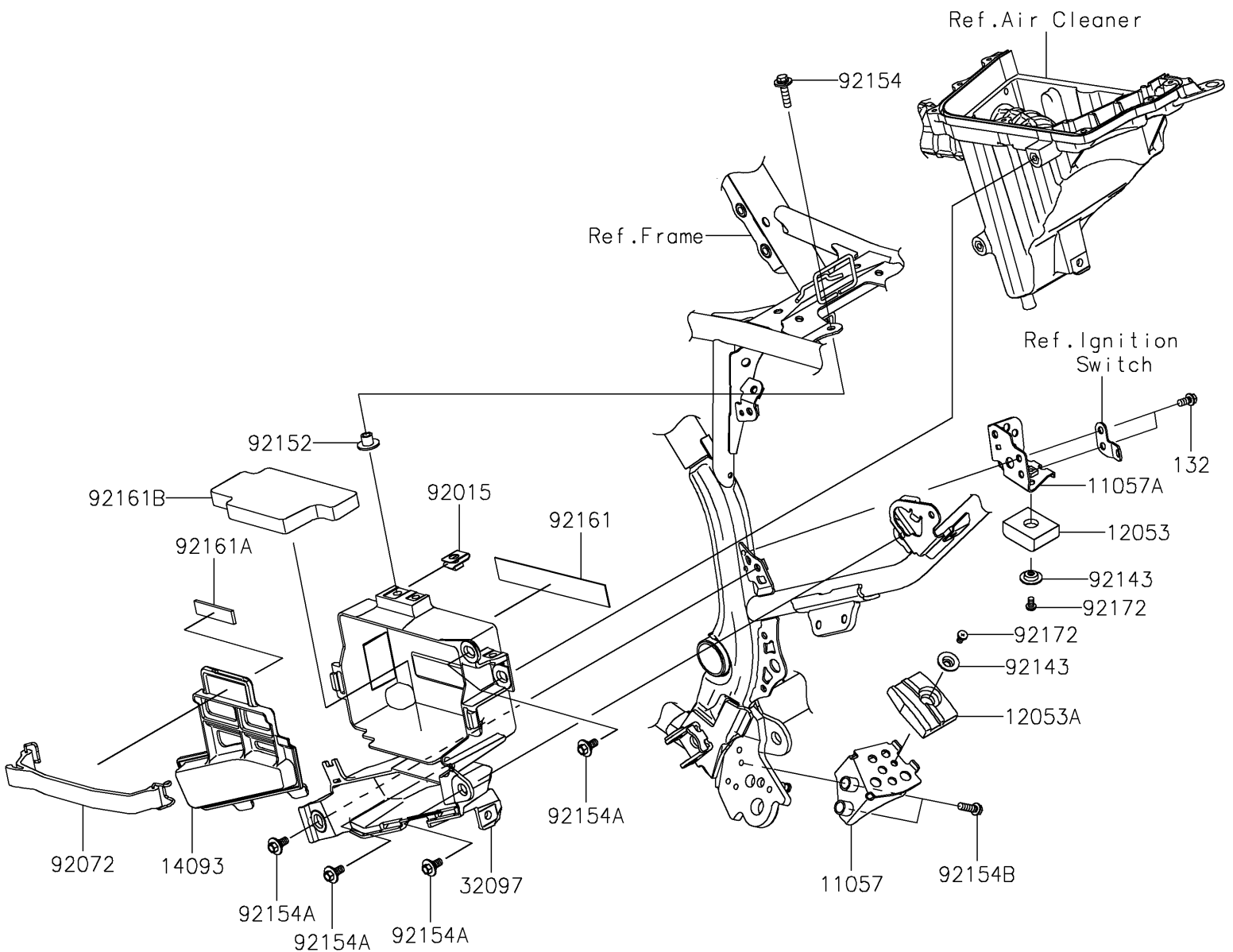

# 2022 KLX<sup>®</sup> 230

## PARTS LIST

### Frame Fittings



**ITEM NAME**

**PART NUMBER**

**QUANTITY**

---