

# 2022 VULCAN® S

## PARTS DIAGRAM

### Owner's Tools

F2810

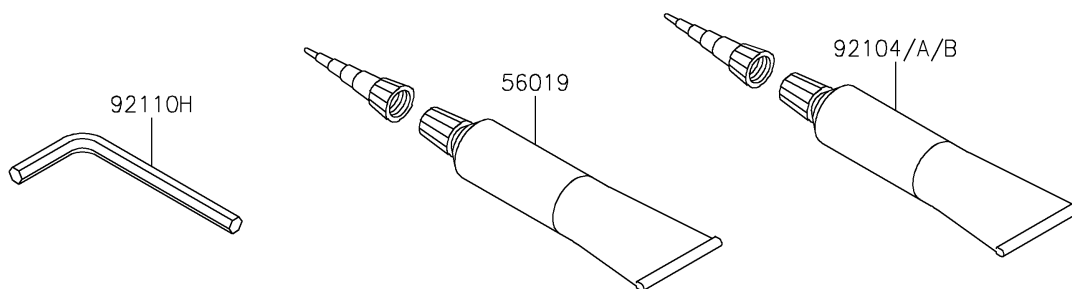
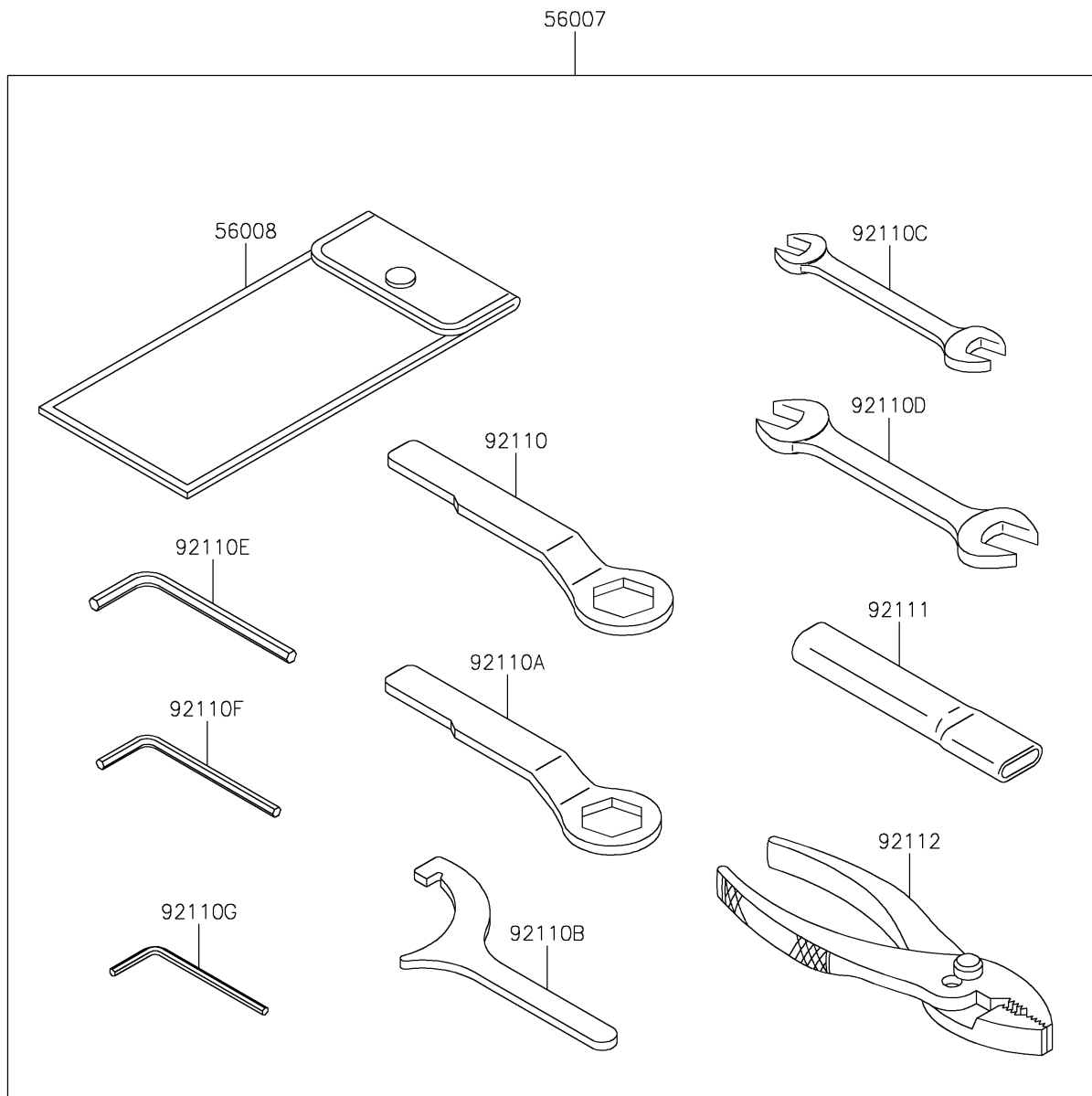

# 2022 VULCAN® S

## PARTS LIST

### Owner's Tools

**Kawasaki**

Let the Good Times Roll®

**ITEM NAME**

**PART NUMBER**

**QUANTITY**

---