

# 2009 Ninja<sup>®</sup> ZX<sup>™</sup>-10R

## PARTS DIAGRAM

### Front Wheel

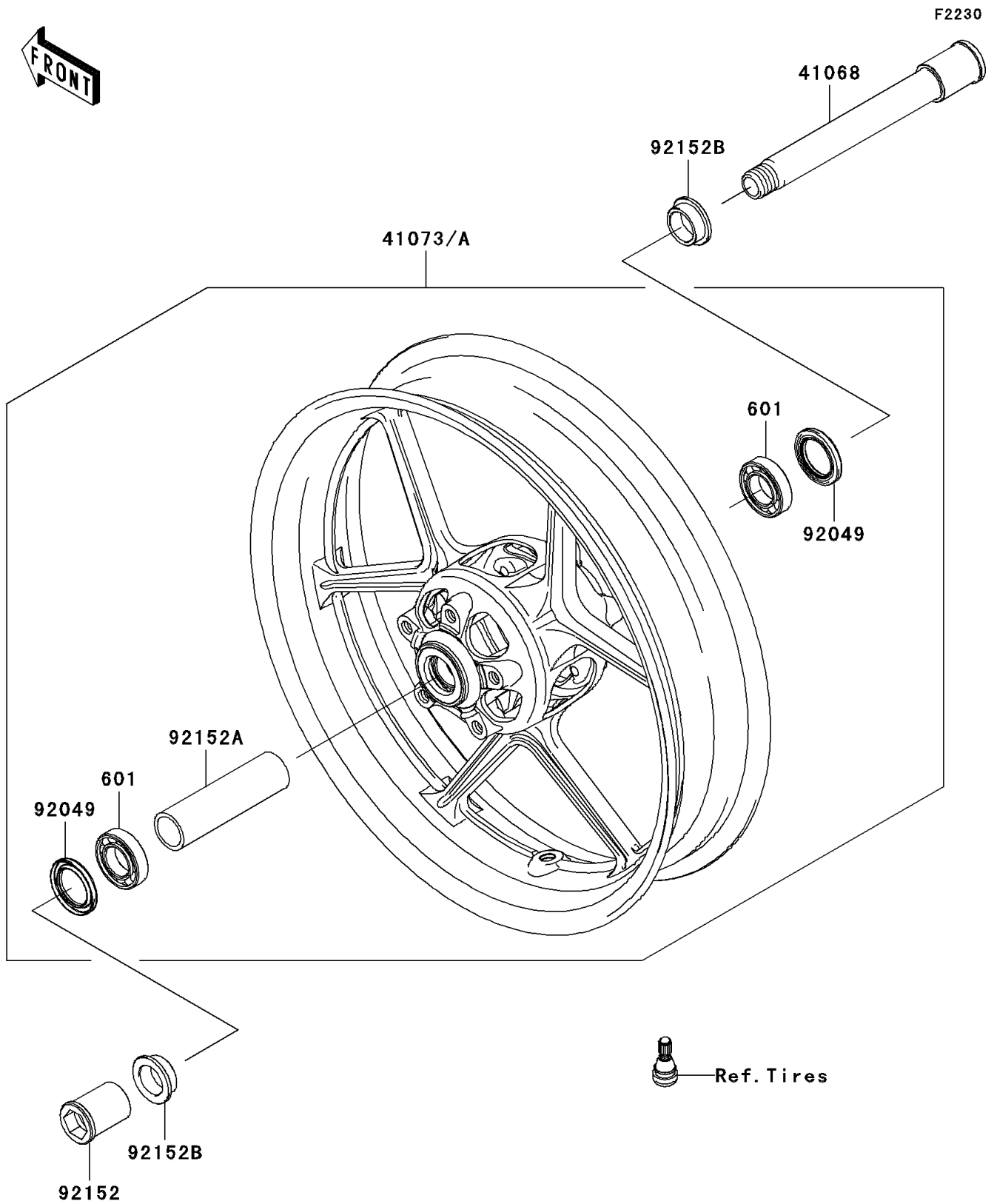

# 2009 Ninja® ZX™-10R

## PARTS LIST

### Front Wheel

**ITEM NAME**

**PART NUMBER**

**QUANTITY**

---