

1998 KX80

PARTS DIAGRAM

Cables

F2540

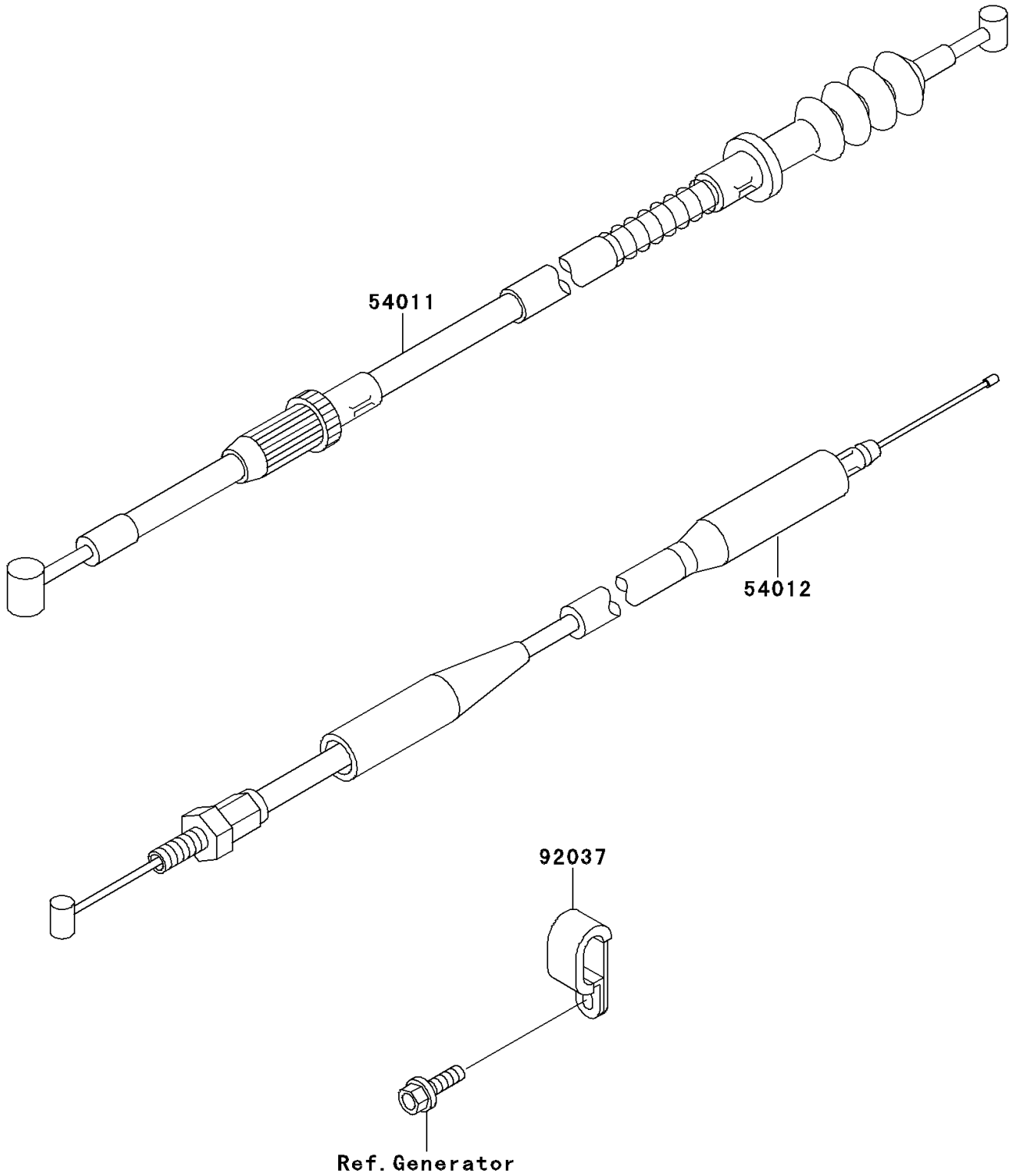

1998 KX80

PARTS LIST

Cables

| ITEM NAME | PART NUMBER | QUANTITY |
|-----------|-------------|----------|
|-----------|-------------|----------|
