

# 2020 NINJA H2™ CARBON

## PARTS DIAGRAM

### Suspension/Shock Absorber

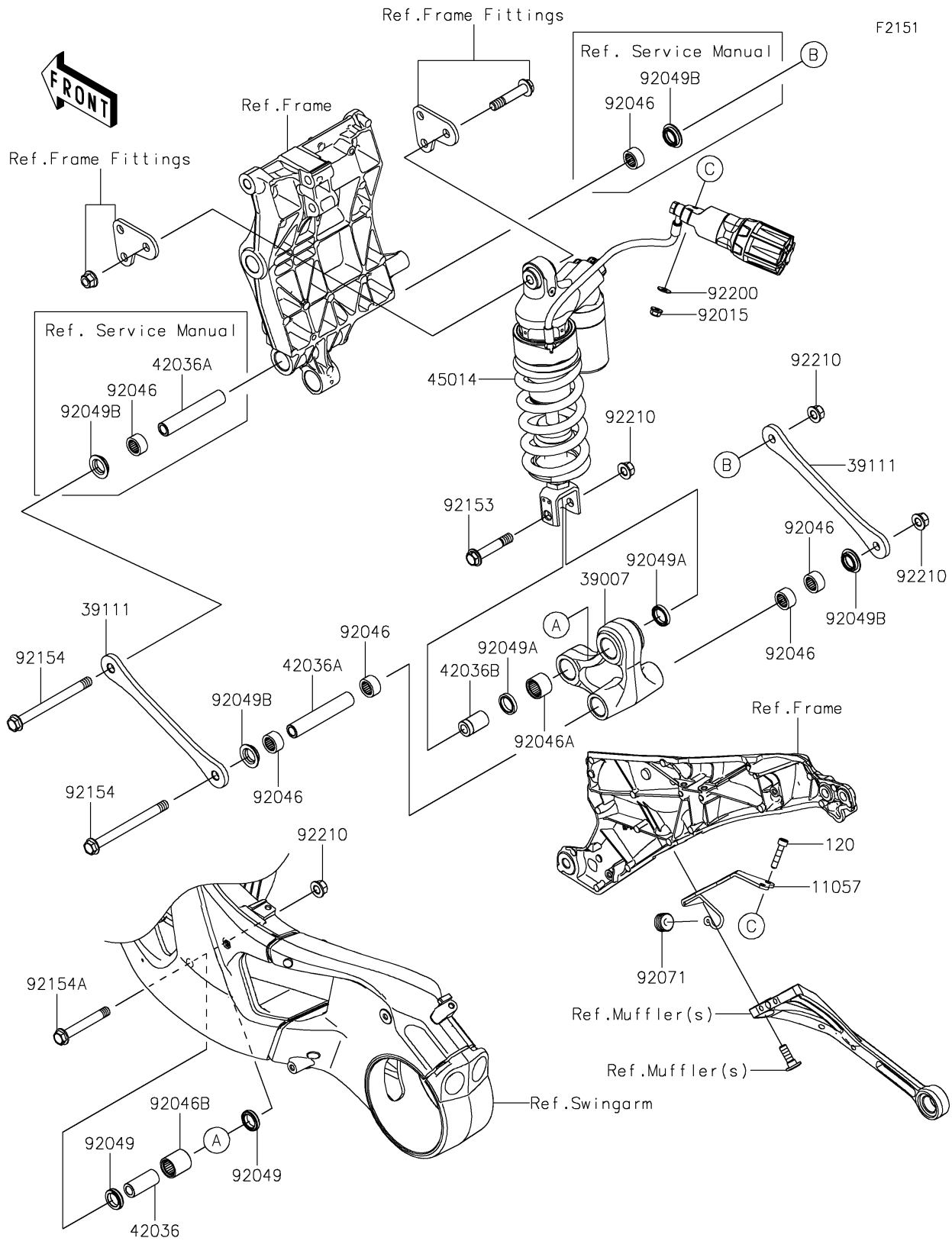

# 2020 NINJA H2™ CARBON

## PARTS LIST

### Suspension/Shock Absorber

**ITEM NAME**

**PART NUMBER**

**QUANTITY**

---