

2002 KX65

PARTS DIAGRAM

Gear Change Mechanism

E1370

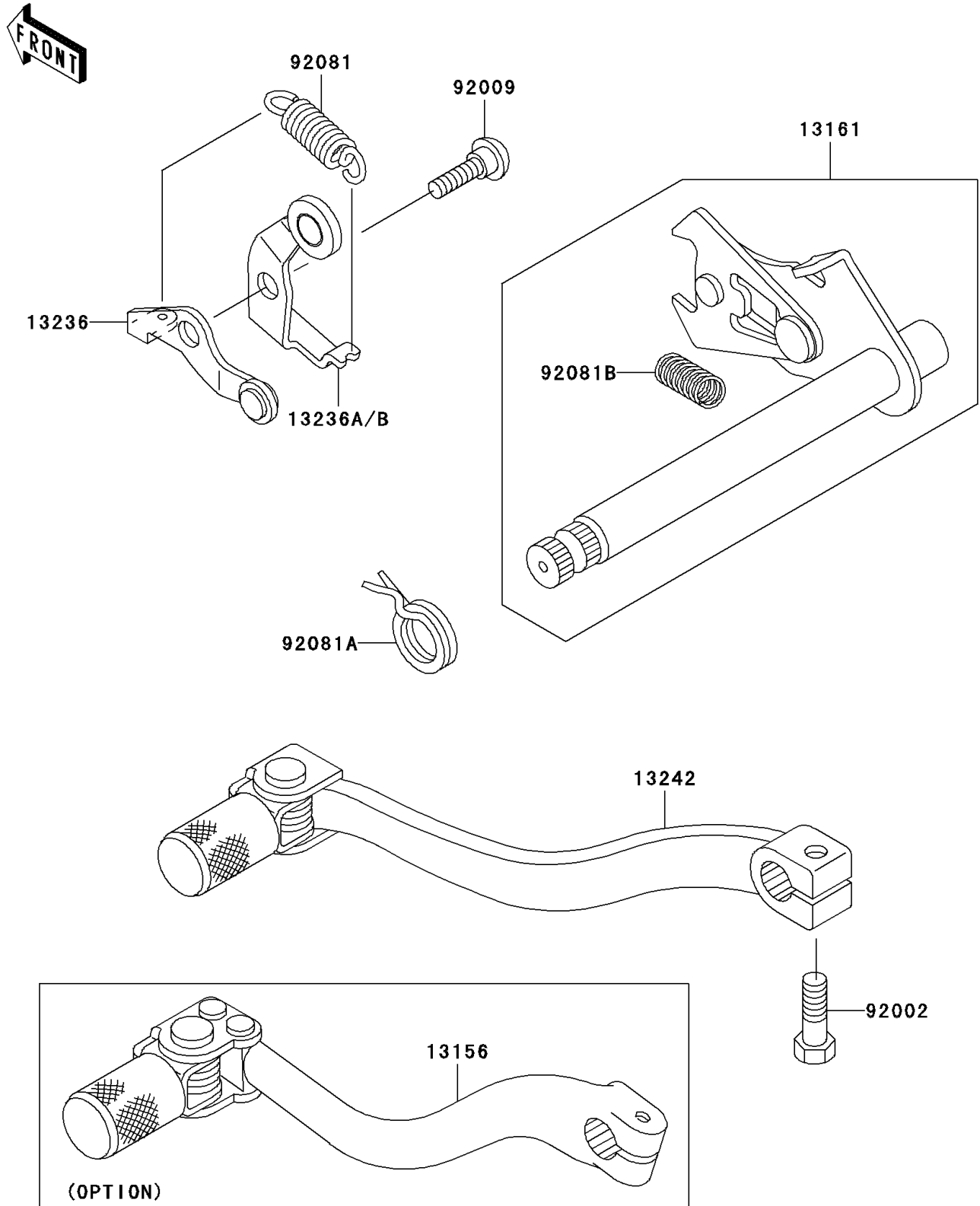

2002 KX65

PARTS LIST

Gear Change Mechanism

ITEM NAME	PART NUMBER	QUANTITY
LEVER-CHANGE,PEDAL (Ref # 13156)	13156-1347	1
LEVER-COMP-CHANGE SHAFT (Ref # 13161)	13161-1280	1
LEVER-COMP,CHANGE DRUM (Ref # 13236)	13236-1026	1
LEVER-COMP,CHANGE (Ref # 13236B)	13236-1376	1
LEVER-ASSY-CHANGE,PEDAL,STEEL (Ref # 13242)	13242-1366	1
BOLT,6X20 (Ref # 92002)	92002-1237	1
SCREW,CHANGE LEVER (Ref # 92009)	92009-1102	1
SPRING,CHANGE LEVER (Ref # 92081)	92081-1109	1
SPRING,TENSION (Ref # 92081A)	92081-1129	1
SPRING,CHANGE LEVER (Ref # 92081B)	92081-1275	1