

2008 Vulcan® 1600 Nomad™

PARTS DIAGRAM

Stand(s)

F2190

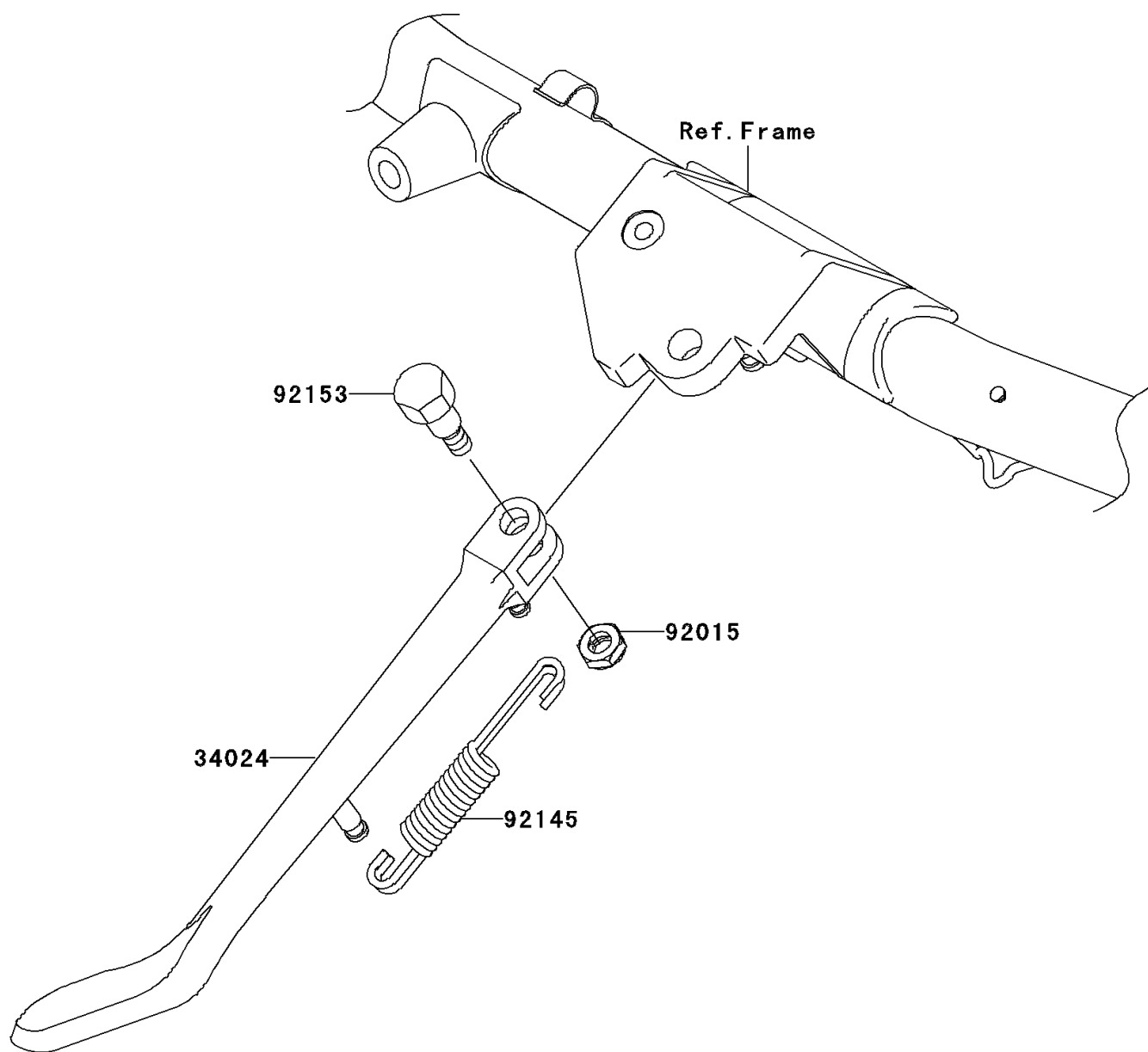

2008 Vulcan® 1600 Nomad™

PARTS LIST

Stand(s)

ITEM NAME	PART NUMBER	QUANTITY
STAND-SIDE (Ref # 34024)	34024-1330	1
NUT,LOCK,10MM,BLACK (Ref # 92015)	92015-1188	1
SPRING,SIDE STAND (Ref # 92145)	92145-0083	1
BOLT,SIDE STAND,10MM (Ref # 92153)	92153-1416	1