

# 2022 Vulcan<sup>®</sup> S ABS CAFE

## PARTS DIAGRAM

Accessory(Decals)

F2910G

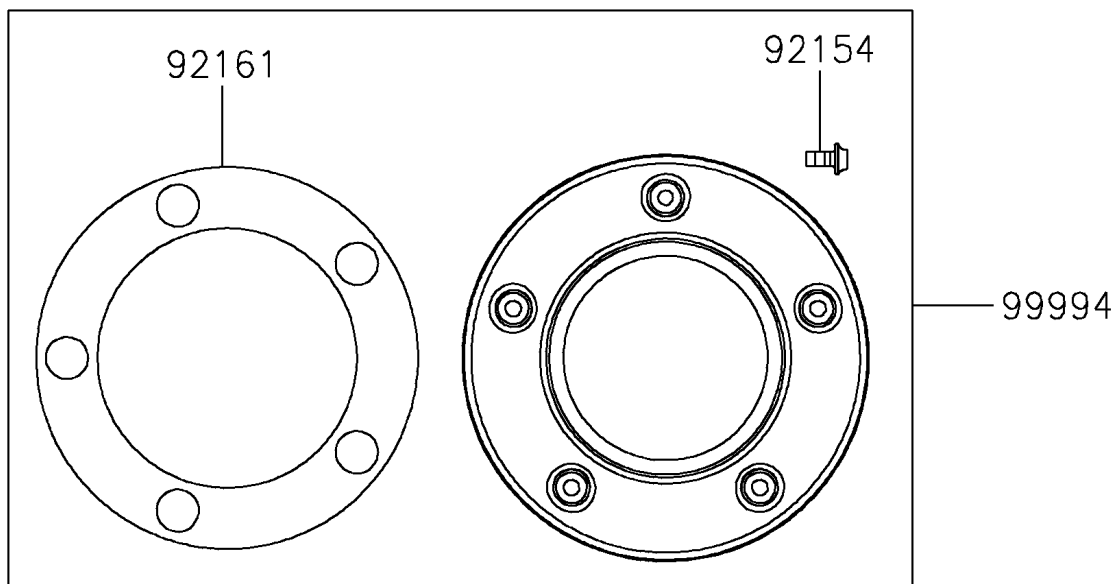

# 2022 Vulcan<sup>®</sup> S ABS CAFE

## PARTS LIST

Accessory(Decals)

**ITEM NAME**

**PART NUMBER**

**QUANTITY**

---