

# 2021 VULCAN® S ABS CAFE

## PARTS DIAGRAM

### Oil Pan

E1434

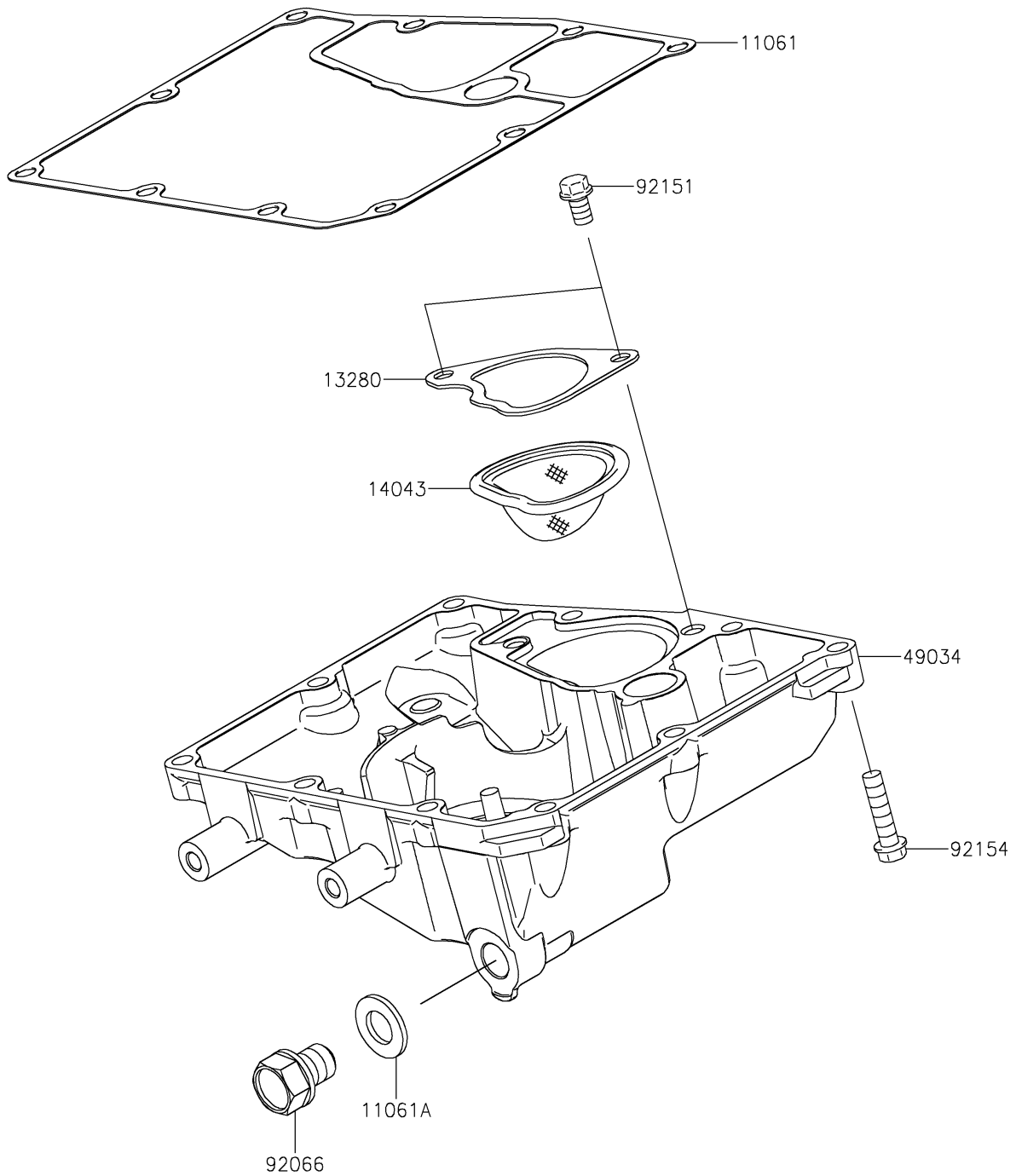

# 2021 VULCAN® S ABS CAFE

## PARTS LIST

Oil Pan

**ITEM NAME**

**PART NUMBER**

**QUANTITY**

---