

# 2002 KX60

## PARTS DIAGRAM

### Cables

F2540

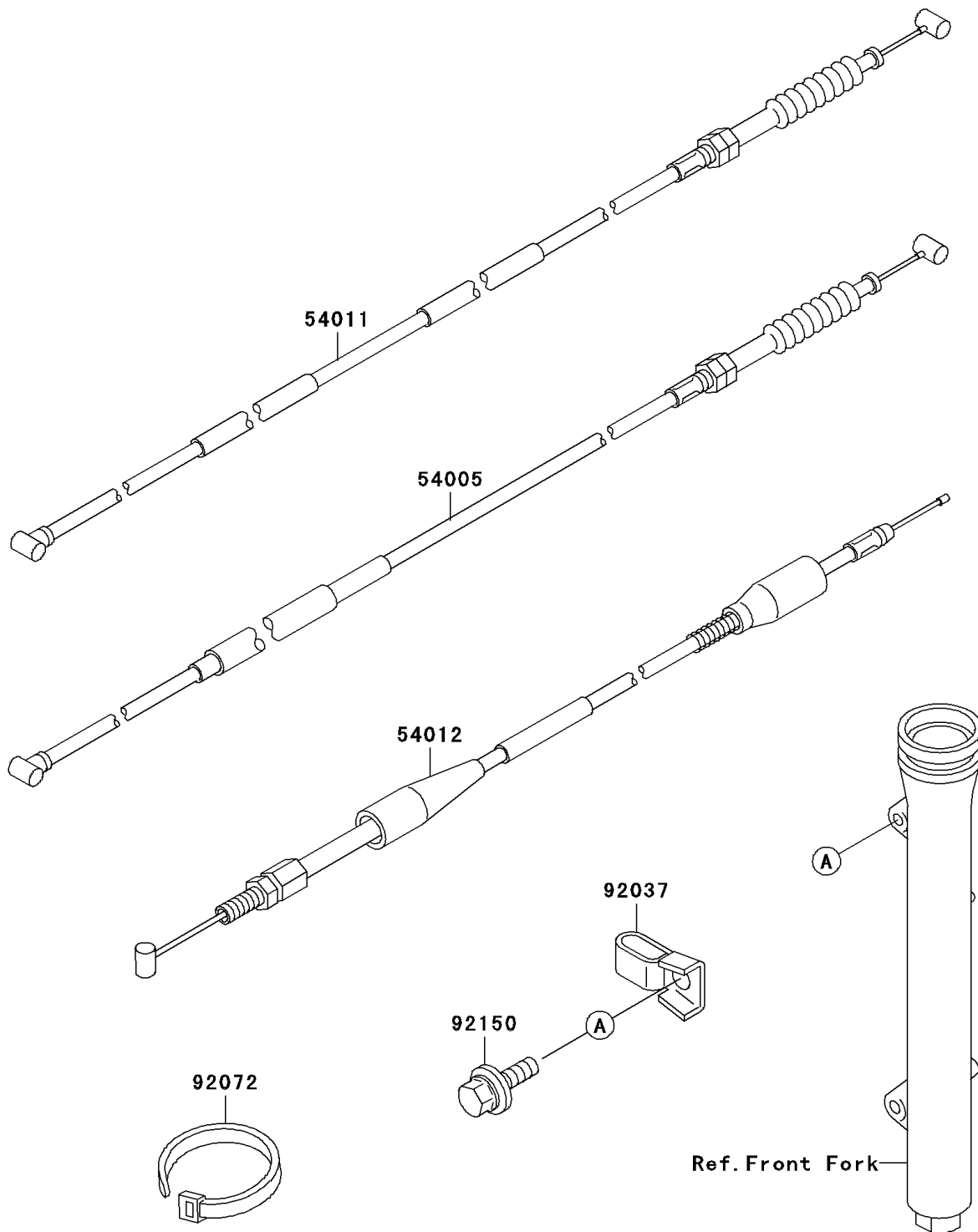

# 2002 KX60

## PARTS LIST

### Cables

**ITEM NAME**

**PART NUMBER**

**QUANTITY**

---