

# 2021 MULE PRO-FXT™ RANCH EDITION

## PARTS DIAGRAM

### Drive Shaft-Rear

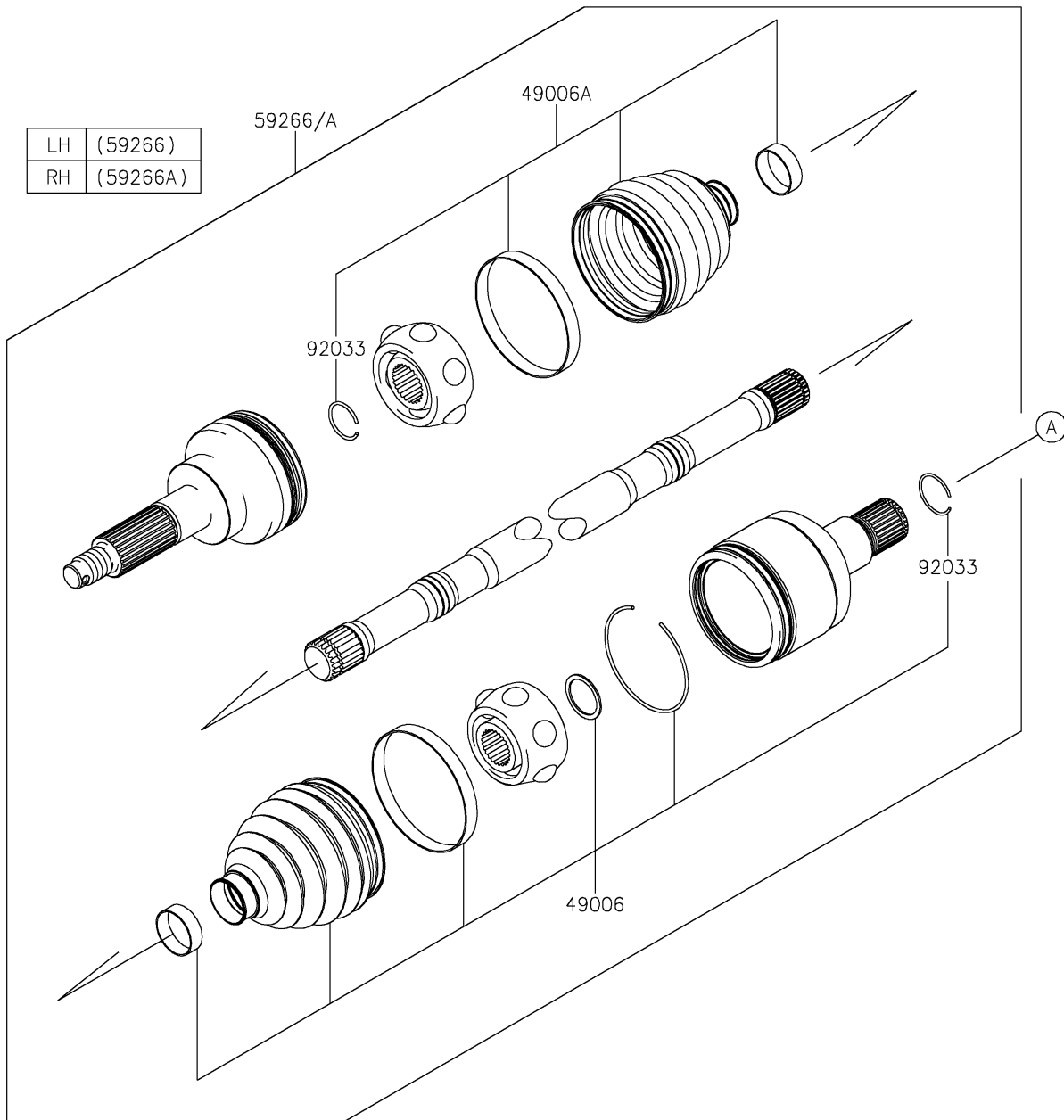
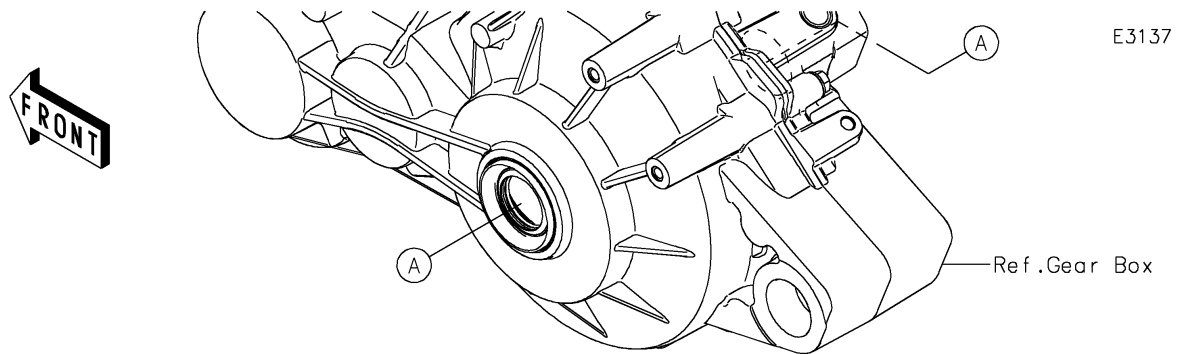

# 2021 MULE PRO-FXT™ RANCH EDITION



## PARTS LIST

### Drive Shaft-Rear

ITEM NAME	PART NUMBER	QUANTITY
-----------	-------------	----------

---