

2021 MULE PRO-FXT™ RANCH EDITION

PARTS DIAGRAM

Water Pump

E3031

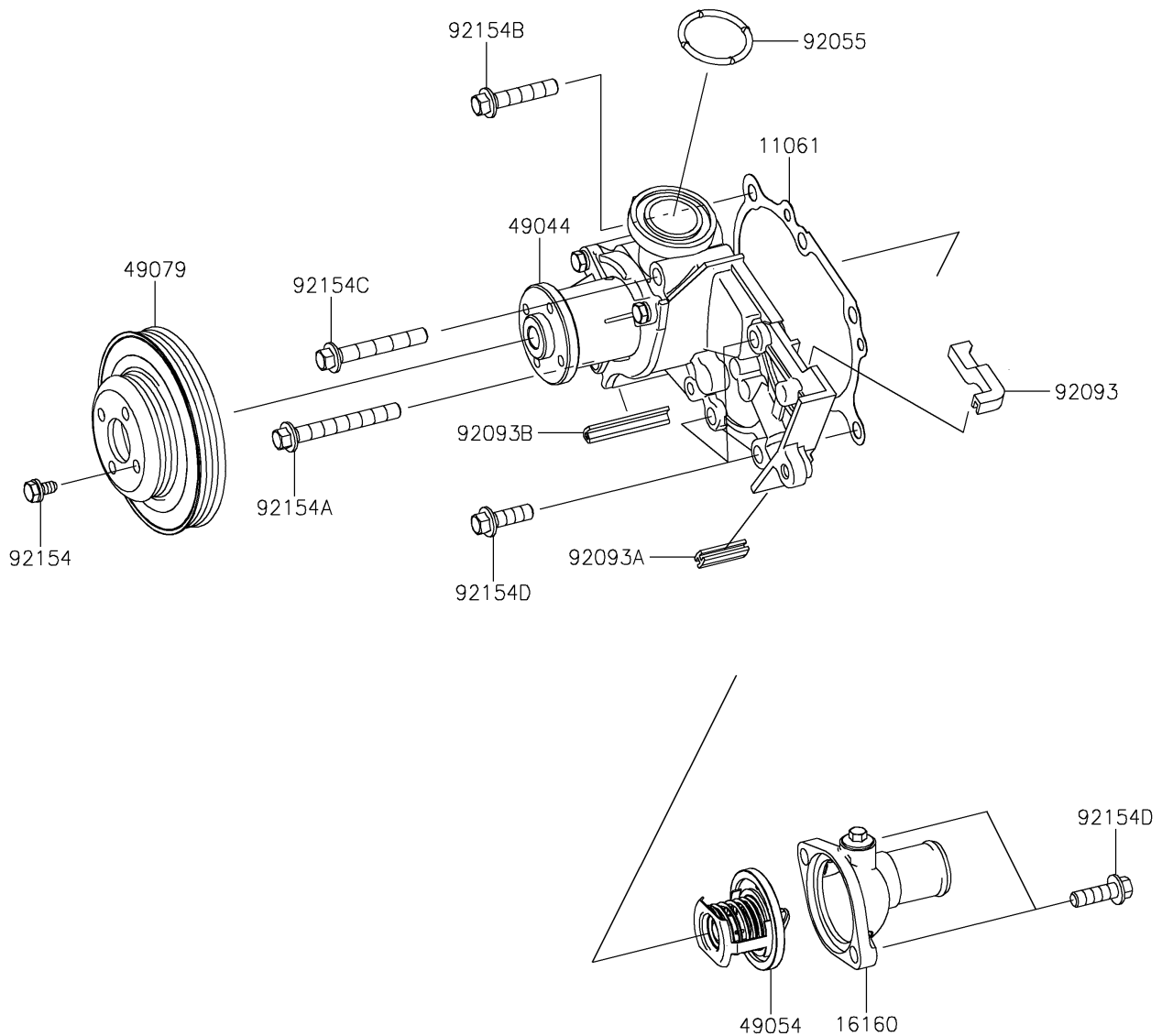

2021 MULE PRO-FXT™ RANCH EDITION

Kawasaki
Let the Good Times Roll®

PARTS LIST

Water Pump

ITEM NAME	PART NUMBER	QUANTITY
-----------	-------------	----------
