

# 2021 MULE PRO-FXT™ RANCH EDITION

## PARTS DIAGRAM

### Crankcase

E1411

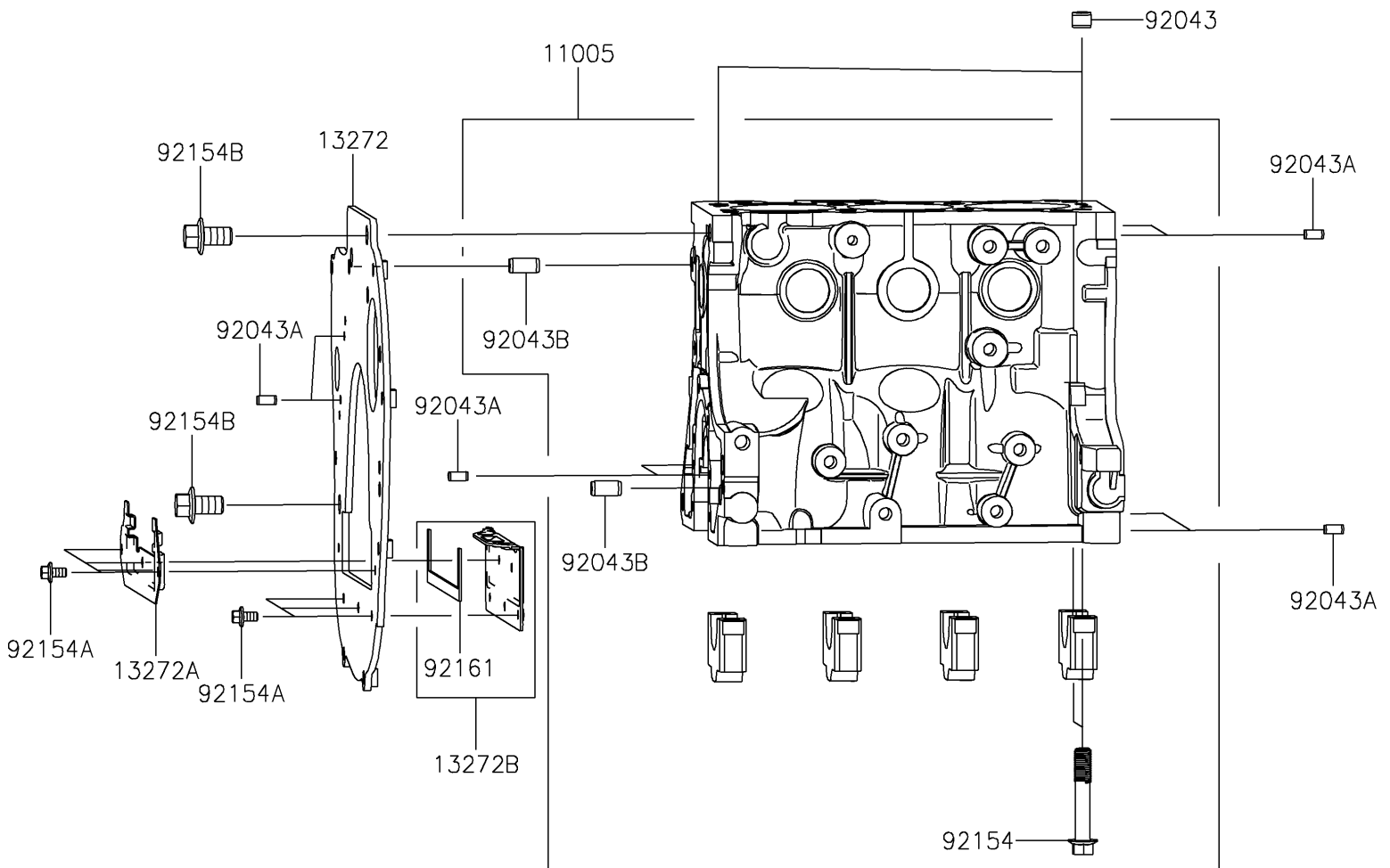

# 2021 MULE PRO-FXT™ RANCH EDITION

**Kawasaki**  
Let the Good Times Roll®

## PARTS LIST

### Crankcase

ITEM NAME	PART NUMBER	QUANTITY
-----------	-------------	----------

---