

# 2021 MULE PRO-FXT™ RANCH EDITION

**Kawasaki**  
Let the Good Times Roll®

## PARTS DIAGRAM

### Driven Converter/Drive Belt

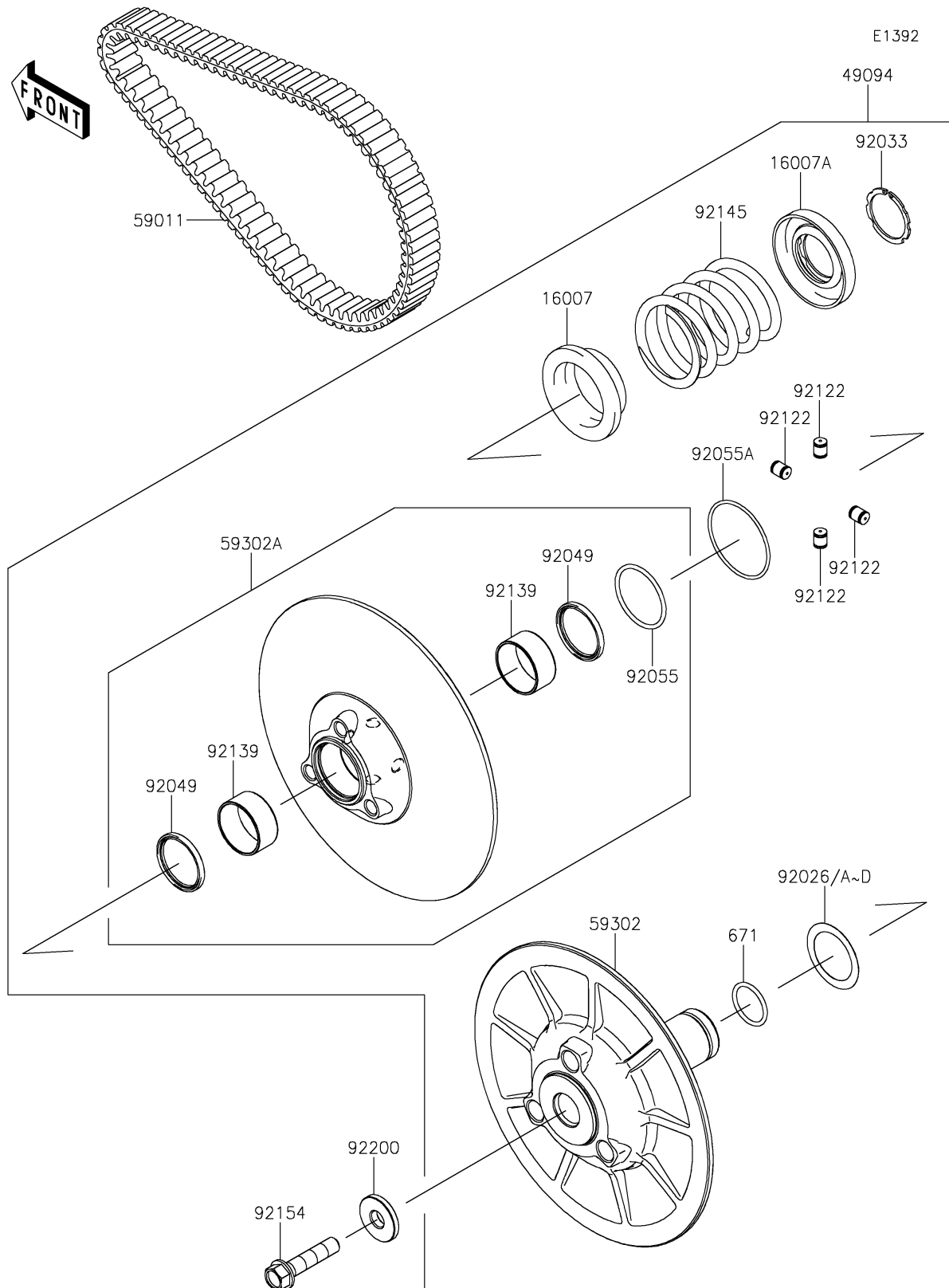

# 2021 MULE PRO-FXT™ RANCH EDITION



## PARTS LIST

### Driven Converter/Drive Belt

ITEM NAME	PART NUMBER	QUANTITY
-----------	-------------	----------

---