

# 2021 NINJA® 650

## PARTS DIAGRAM

### Accessory(Decals)

F2910L

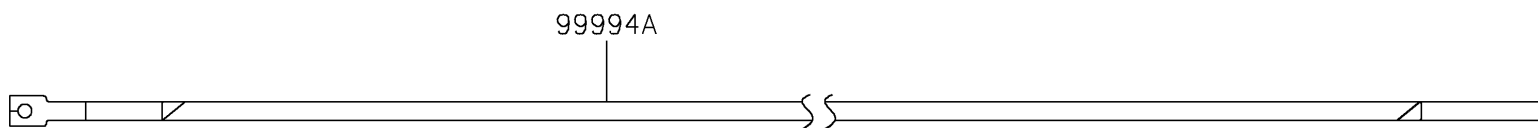
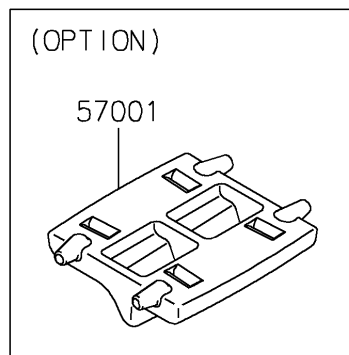

# 2021 NINJA® 650

## PARTS LIST

Accessory(Decals)

**ITEM NAME**

**PART NUMBER**

**QUANTITY**

---