

2018 NINJA® 1000 ABS

PARTS DIAGRAM

Brake Pedal/Torque Link

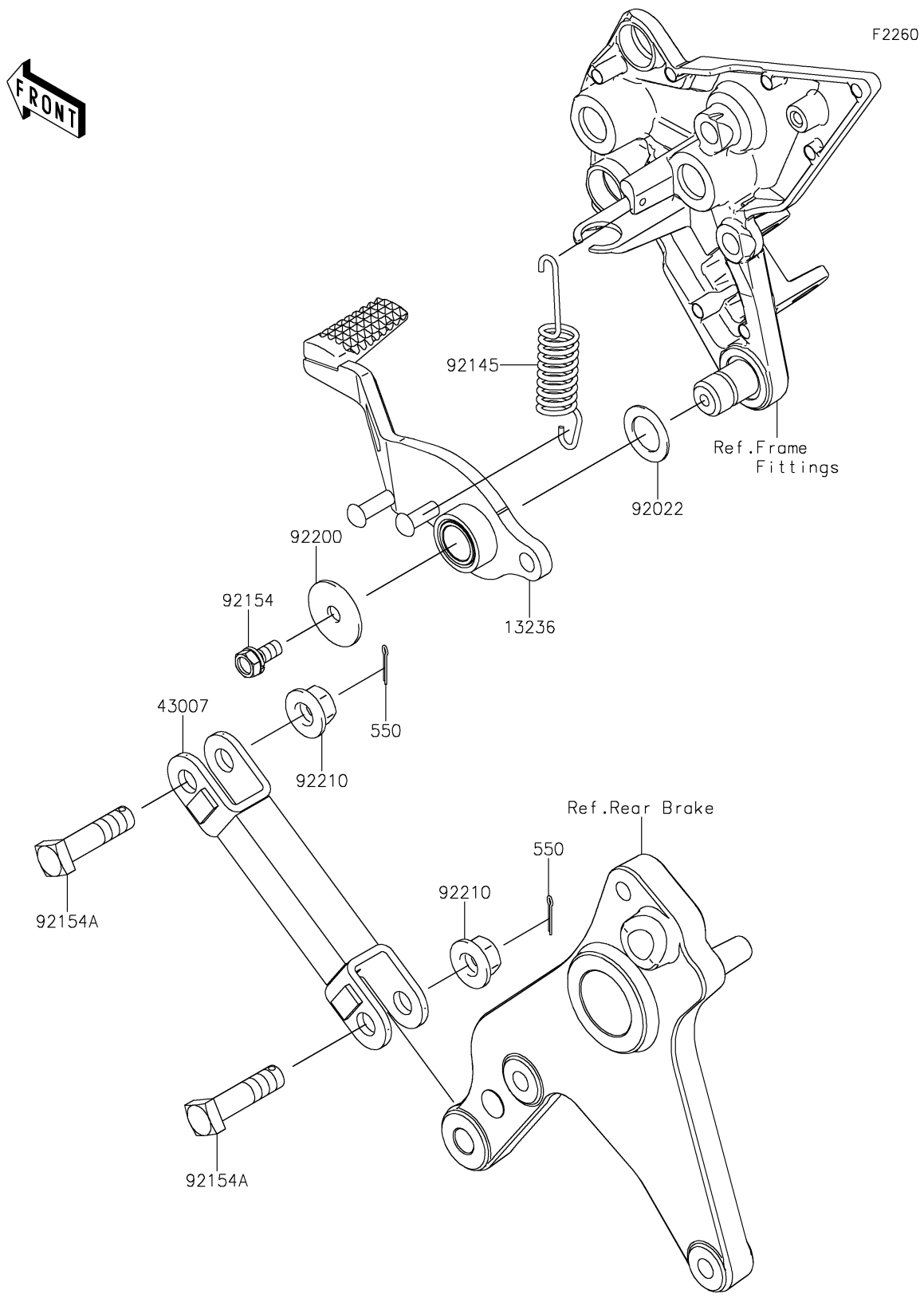

2018 NINJA® 1000 ABS

PARTS LIST

Brake Pedal/Torque Link

ITEM NAME	PART NUMBER	QUANTITY
LEVER-COMP (Ref # 13236)	13236-0741	1
ROD-TORQUE,F.S.BLACK (Ref # 43007)	43007-0016-18R	1
PIN-COTTER,2.0X15 (Ref # 550)	550AA2015	2
WASHER,15.3X24X1 (Ref # 92022)	92022-326	1
SPRING,2.0X70 (Ref # 92145)	92145-1753	1
BOLT,UPSET-WS,6X14 (Ref # 92154)	92154-0293	1
BOLT,10X39.5 (Ref # 92154A)	92154-2327	2
WASHER,7X28X1.6 (Ref # 92200)	92200-0279	1
NUT,FLANGED,10MM (Ref # 92210)	92210-1522	2