

2020 NINJA® 650 ABS

PARTS DIAGRAM

Crankcase

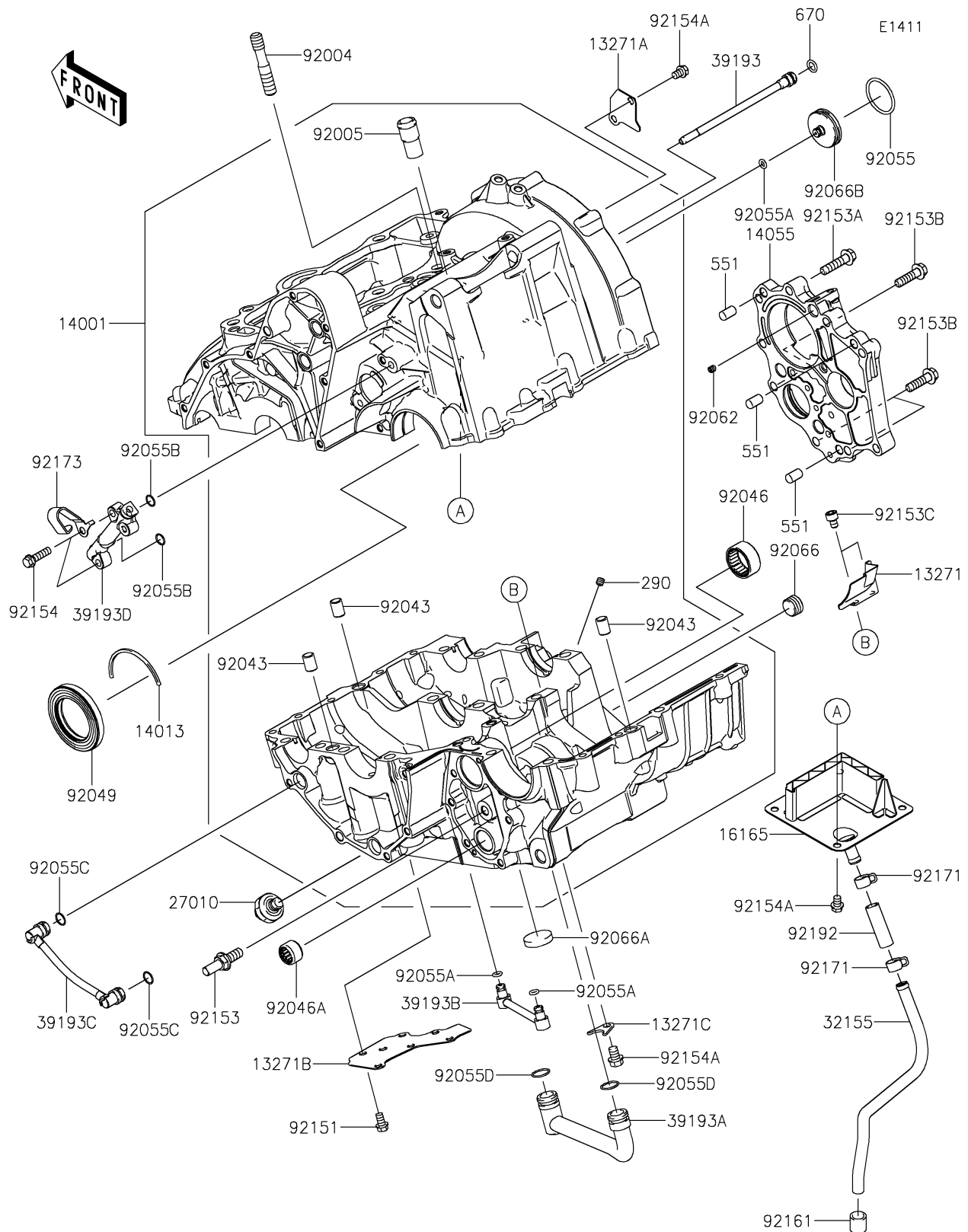

2020 NINJA® 650 ABS

PARTS LIST

Crankcase

ITEM NAME

PART NUMBER

QUANTITY
