

2020 CONCOURS®14 ABS

PARTS DIAGRAM

Rear Brake

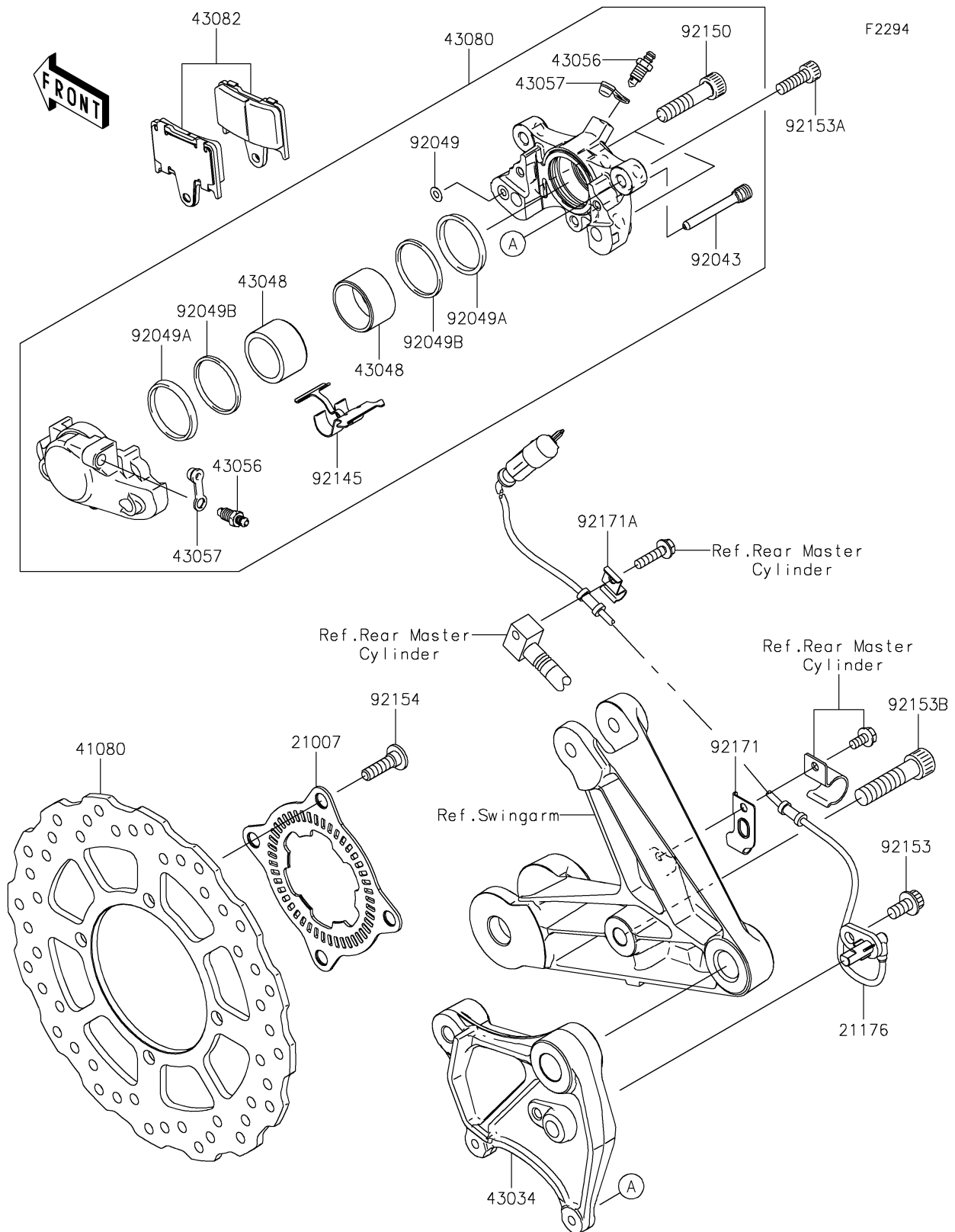

2020 CONCOURS®14 ABS

PARTS LIST

Rear Brake

ITEM NAME

PART NUMBER

QUANTITY
