

2020 CONCOURS®14 ABS

PARTS DIAGRAM

Battery Case

F2132

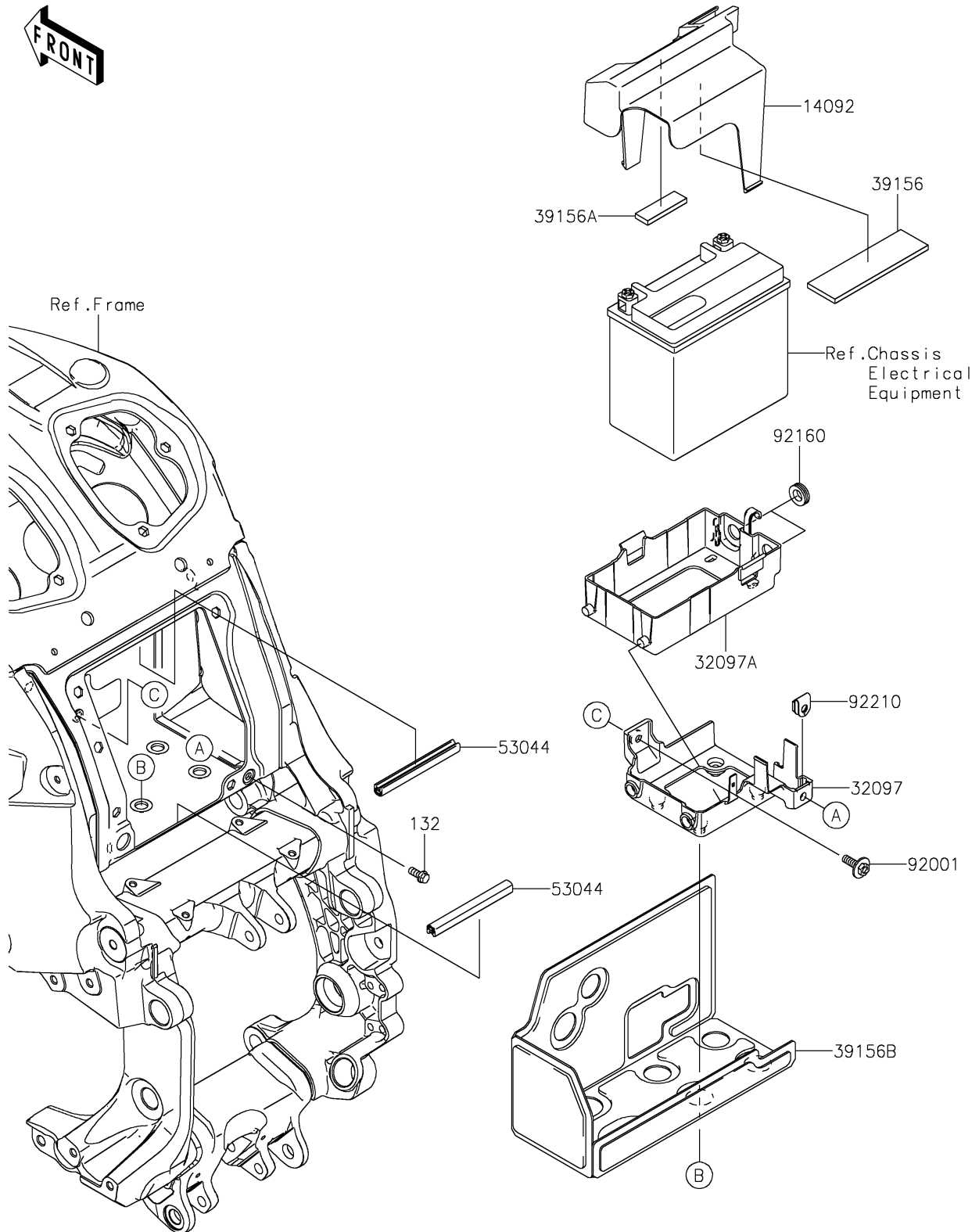

2020 CONCOURS®14 ABS

PARTS LIST

Battery Case

ITEM NAME

PART NUMBER

QUANTITY
