

# 2020 CONCOURS®14 ABS

## PARTS DIAGRAM

### Ignition System

E1830

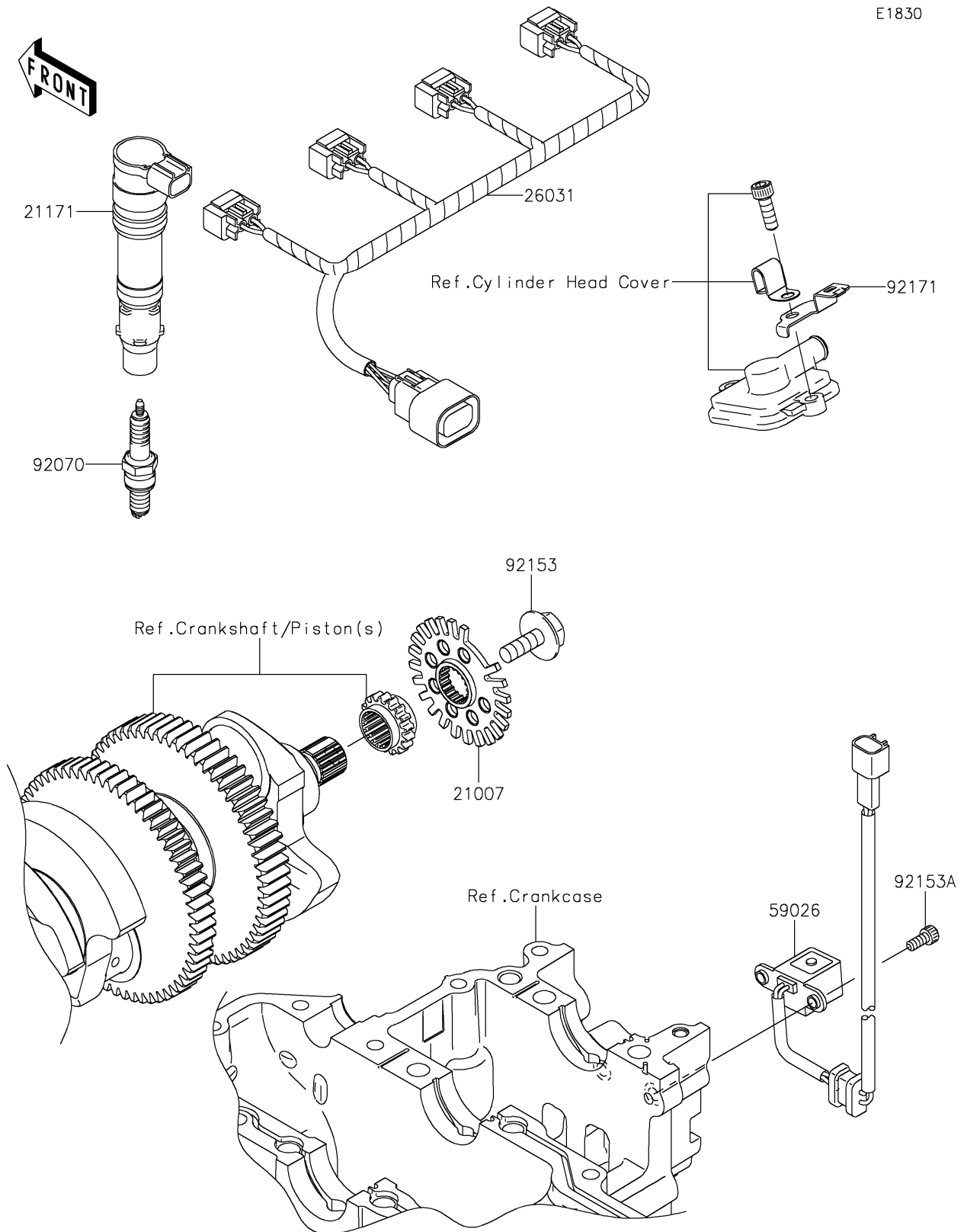

# 2020 CONCOURS®14 ABS

## PARTS LIST

### Ignition System

**ITEM NAME**

**PART NUMBER**

**QUANTITY**

---