

# 2020 CONCOURS®14 ABS

## PARTS DIAGRAM

### Fuel Pump

E1520

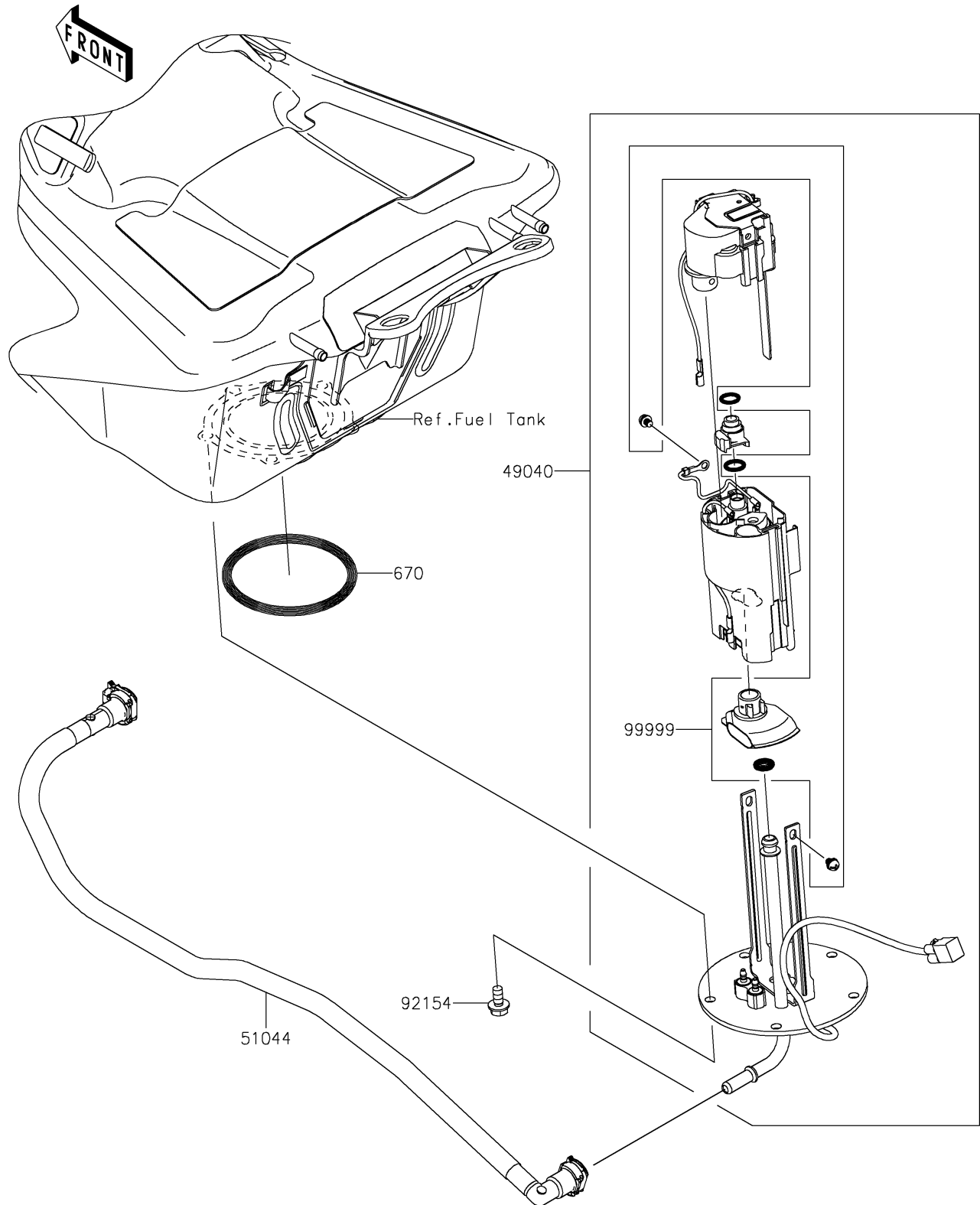

# 2020 CONCOURS®14 ABS

## PARTS LIST

### Fuel Pump

**ITEM NAME**

**PART NUMBER**

**QUANTITY**

---