

2015 MULE PRO-FXT™ EPS LE

PARTS DIAGRAM

Meter(s)

F2530

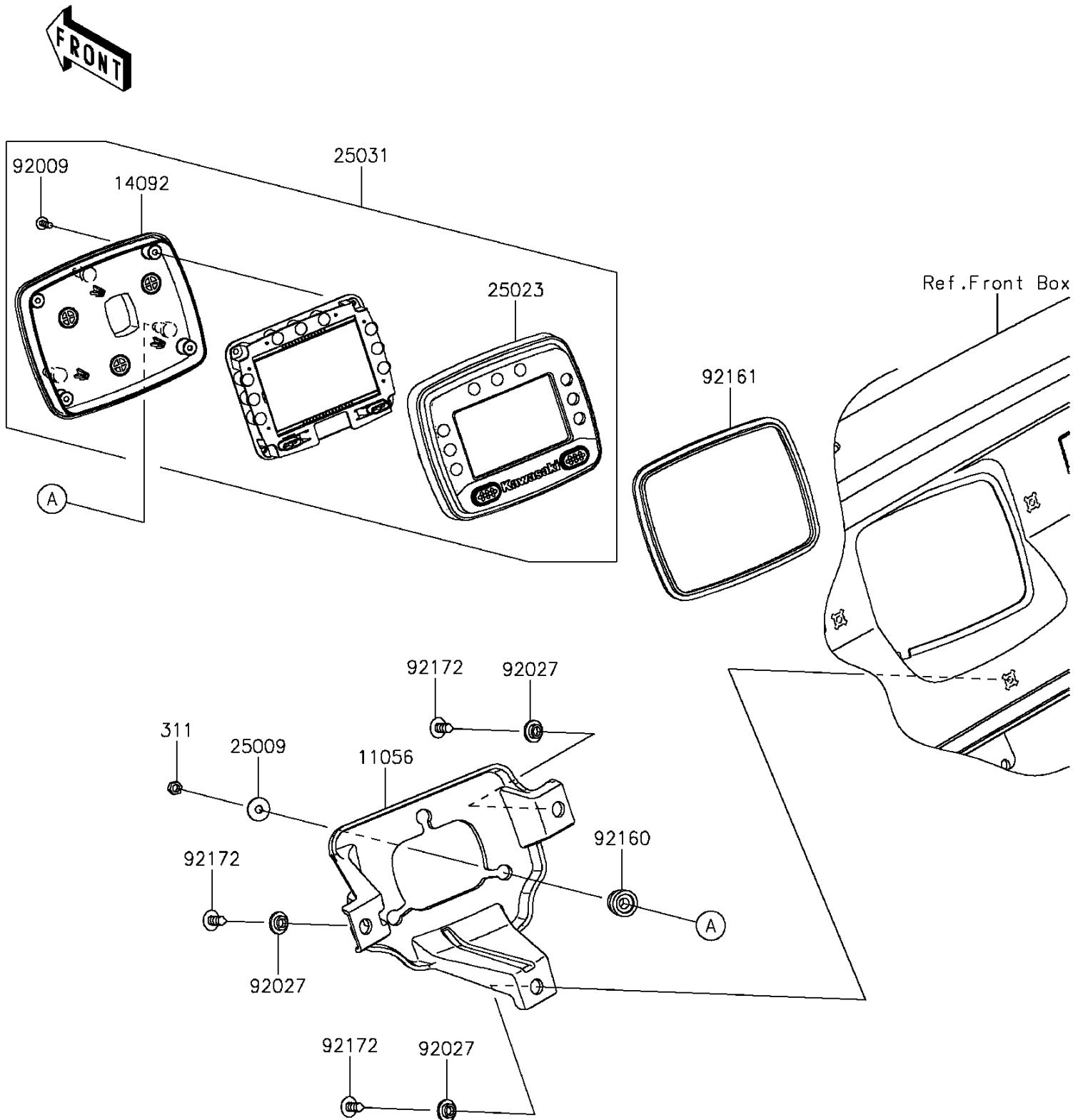

2015 MULE PRO-FXT™ EPS LE

PARTS LIST

Meter(s)

ITEM NAME	PART NUMBER	QUANTITY
-----------	-------------	----------
