

2016 MULE PRO-FXT™ EPS LE

PARTS DIAGRAM

Water Pump

E3031

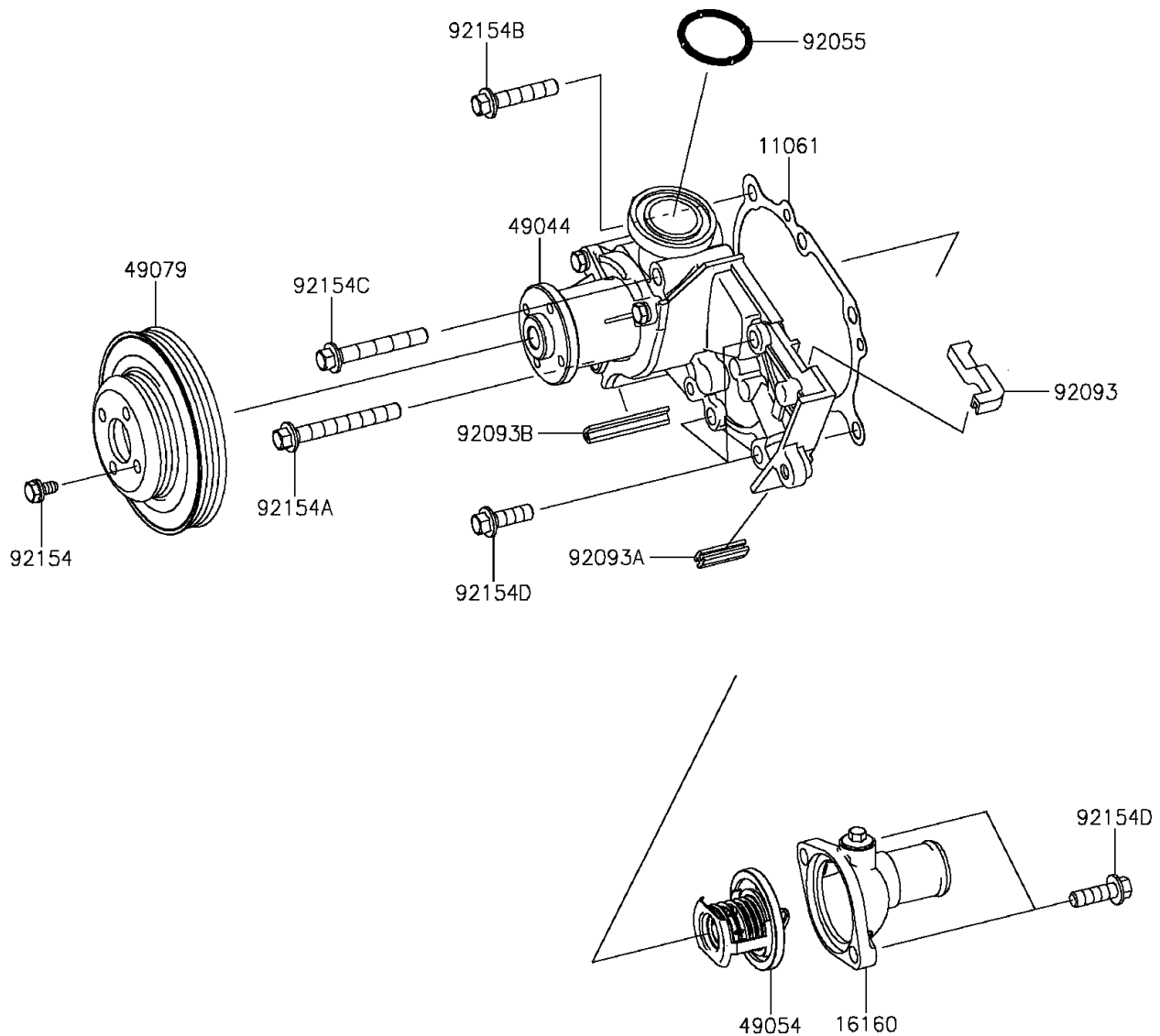

2016 MULE PRO-FXT™ EPS LE

PARTS LIST

Water Pump

ITEM NAME	PART NUMBER	QUANTITY
-----------	-------------	----------
