

2020 MULE PRO-FXR™

PARTS DIAGRAM

Drive Converter

E1391

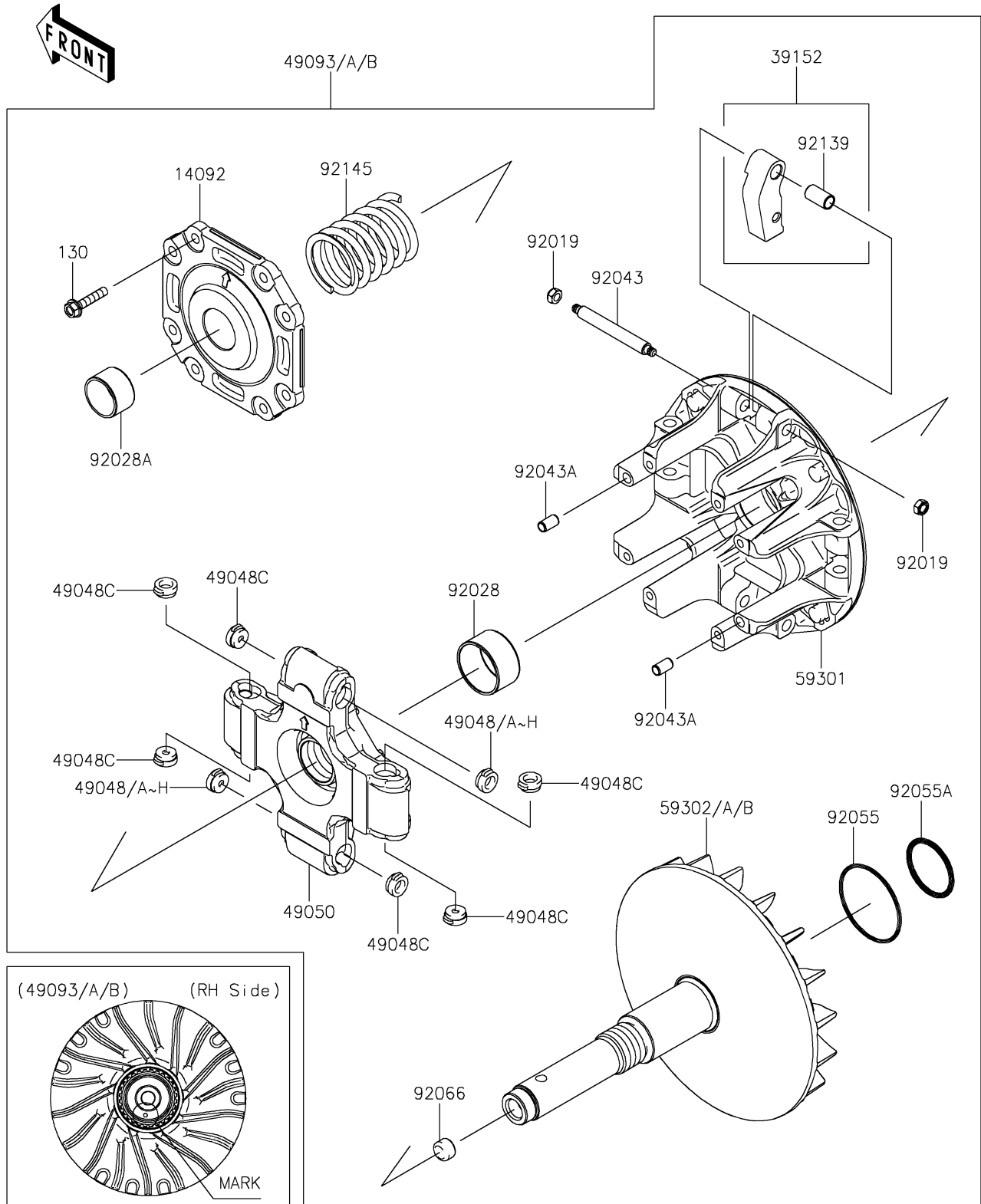

2020 MULE PRO-FXR™

PARTS LIST

Drive Converter

ITEM NAME	PART NUMBER	QUANTITY
BOLT-FLANGED,6X30 (Ref # 130)	130CA0630	8
COVER (Ref # 14092)	14092-1201	1
WEIGHT-RAMP (Ref # 39152)	39152-0039	4
SHOE,T=7.2 (Ref # 49048)	49048-1087	AR
SHOE,T=7.3 (Ref # 49048A)	49048-1088	AR
SHOE,T=7.4 (Ref # 49048B)	49048-1089	AR
SHOE,T=7.5 (Ref # 49048C)	49048-1090	8
SHOE,T=7.6 (Ref # 49048D)	49048-1091	AR
SHOE,T=7.7 (Ref # 49048E)	49048-1092	AR
SHOE,T=7.8 (Ref # 49048F)	49048-1093	AR
SHOE,T=7.9 (Ref # 49048G)	49048-1094	AR
SHOE,T=8.0 (Ref # 49048H)	49048-1095	AR
SPIDER (Ref # 49050)	49050-1083	1
CONVERTER-DRIVE,B MARK,WHITE (Ref # 49093)	49093-0071	1
CONVERTER-DRIVE,A MARK,BLUE (Ref # 49093A)	49093-0072	1
CONVERTER-DRIVE,C MARK,YELLOW (Ref # 49093B)	49093-0073	1
SHEAVE-MOVABLE (Ref # 59301)	59301-0025	1
SHEAVE-COMP,B MARK,WHITE (Ref # 59302)	59302-0092	1
SHEAVE-COMP,A MARK,BLUE (Ref # 59302A)	59302-0093	1
SHEAVE-COMP,C MARK,YELLOW (Ref # 59302B)	59302-0094	1
NUT,LOCK,6MM (Ref # 92019)	92019-008	8
BUSHING (Ref # 92028)	92028-1975	1
BUSHING (Ref # 92028A)	92028-1980	1
PIN (Ref # 92043)	92043-0809	4
PIN,6.2X8X14 (Ref # 92043A)	92043-1263	2
RING-O,59.5X2.4 (Ref # 92055)	92055-0753	1
RING-O,3.5X39.7 (Ref # 92055A)	92055-0789	1
PLUG (Ref # 92066)	92066-0784	1
BUSHING,9X11X19.75 (Ref # 92139)	92139-1103	4

2020 MULE PRO-FXR™

PARTS LIST

Drive Converter

ITEM NAME	PART NUMBER	QUANTITY
SPRING (Ref # 92145)	92145-1576	1