

# 2019 MULE PRO-FXT™ EPS CAMO

## PARTS DIAGRAM Crankshaft/Piston(s)

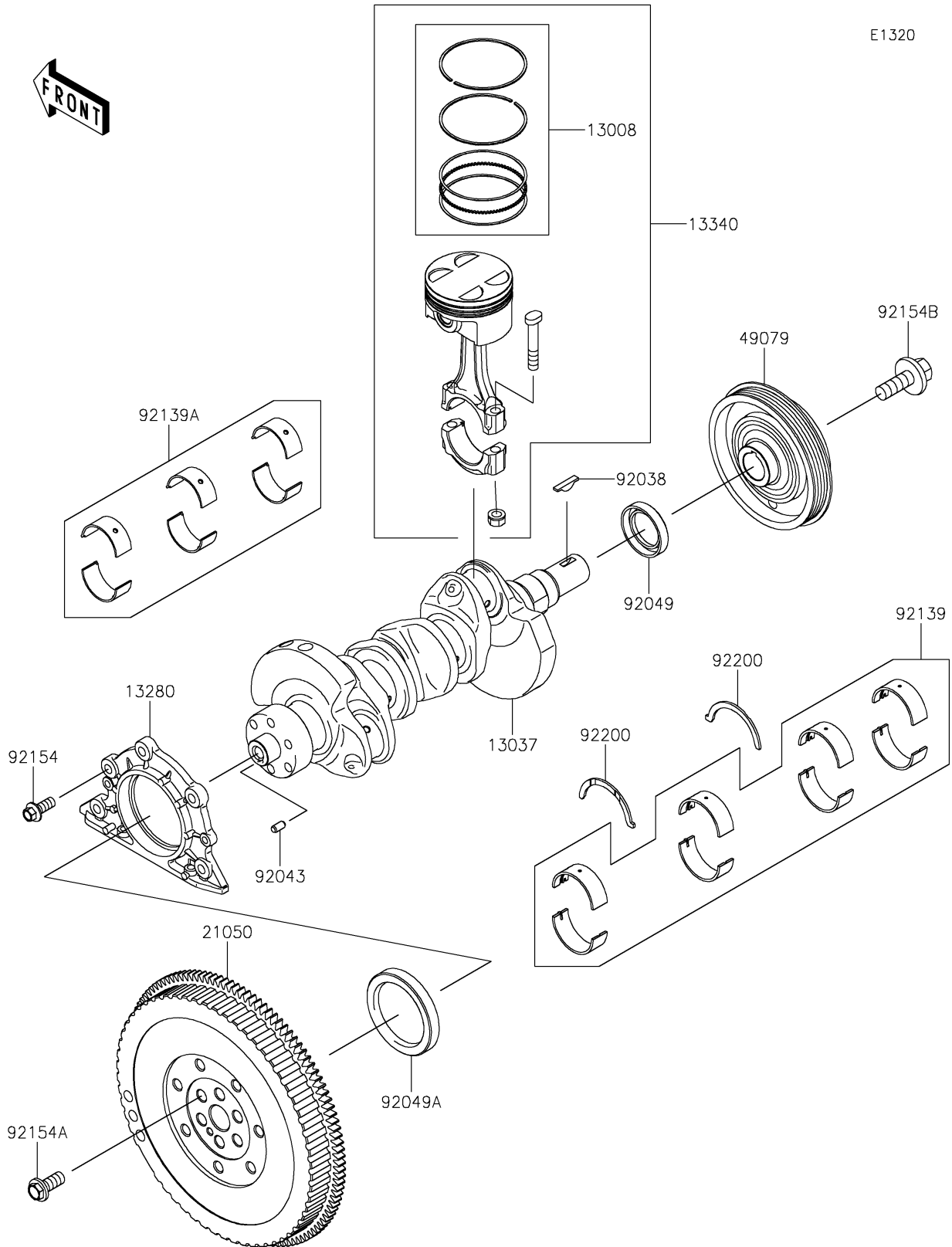

# 2019 MULE PRO-FXT™ EPS CAMO

## PARTS LIST

### Crankshaft/Piston(s)

ITEM NAME	PART NUMBER	QUANTITY
-----------	-------------	----------

---