

# 2020 MULE PRO-FXT™

## PARTS DIAGRAM

### Wheels/Tires

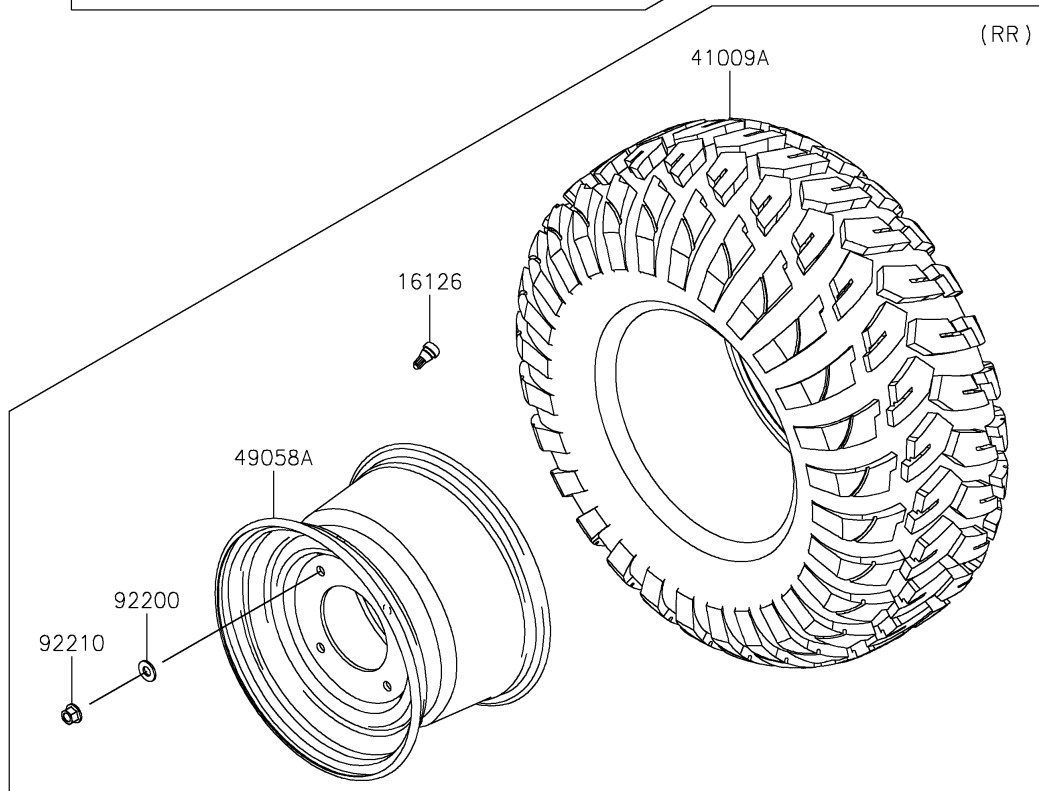
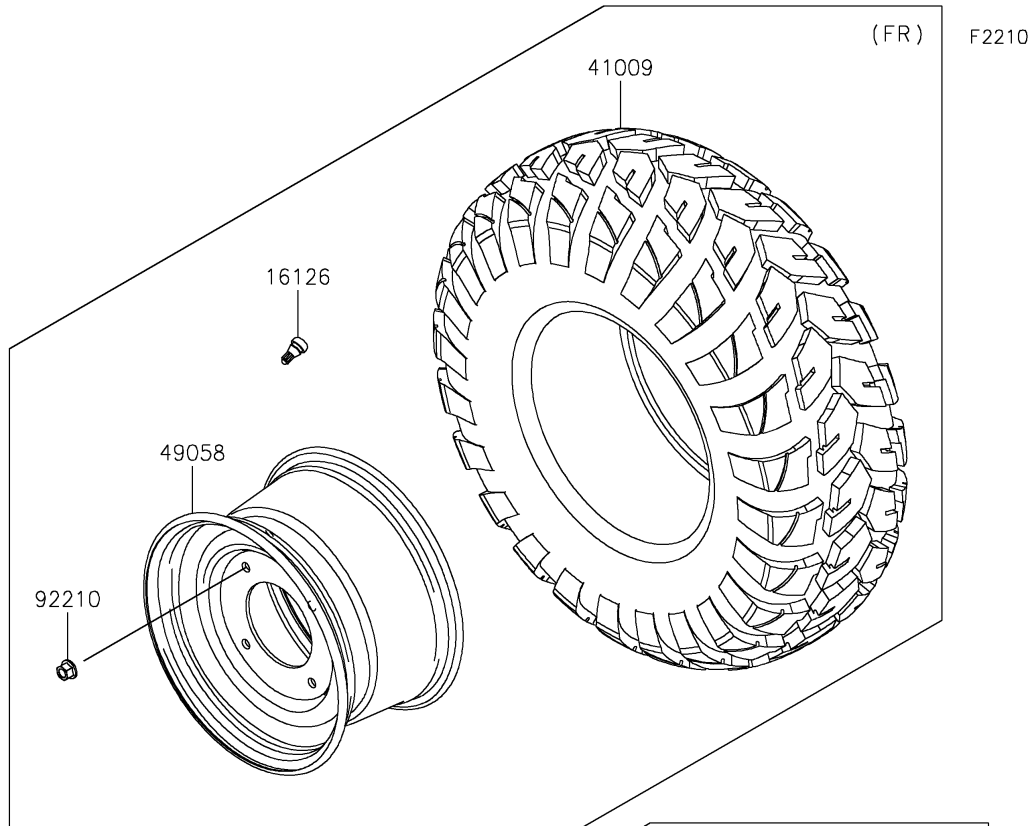

# 2020 MULE PRO-FXT™

## PARTS LIST

### Wheels/Tires

**ITEM NAME**

**PART NUMBER**

**QUANTITY**

---