

# 2018 MULE PRO-DX™ EPS DIESEL

## PARTS DIAGRAM

### Frame

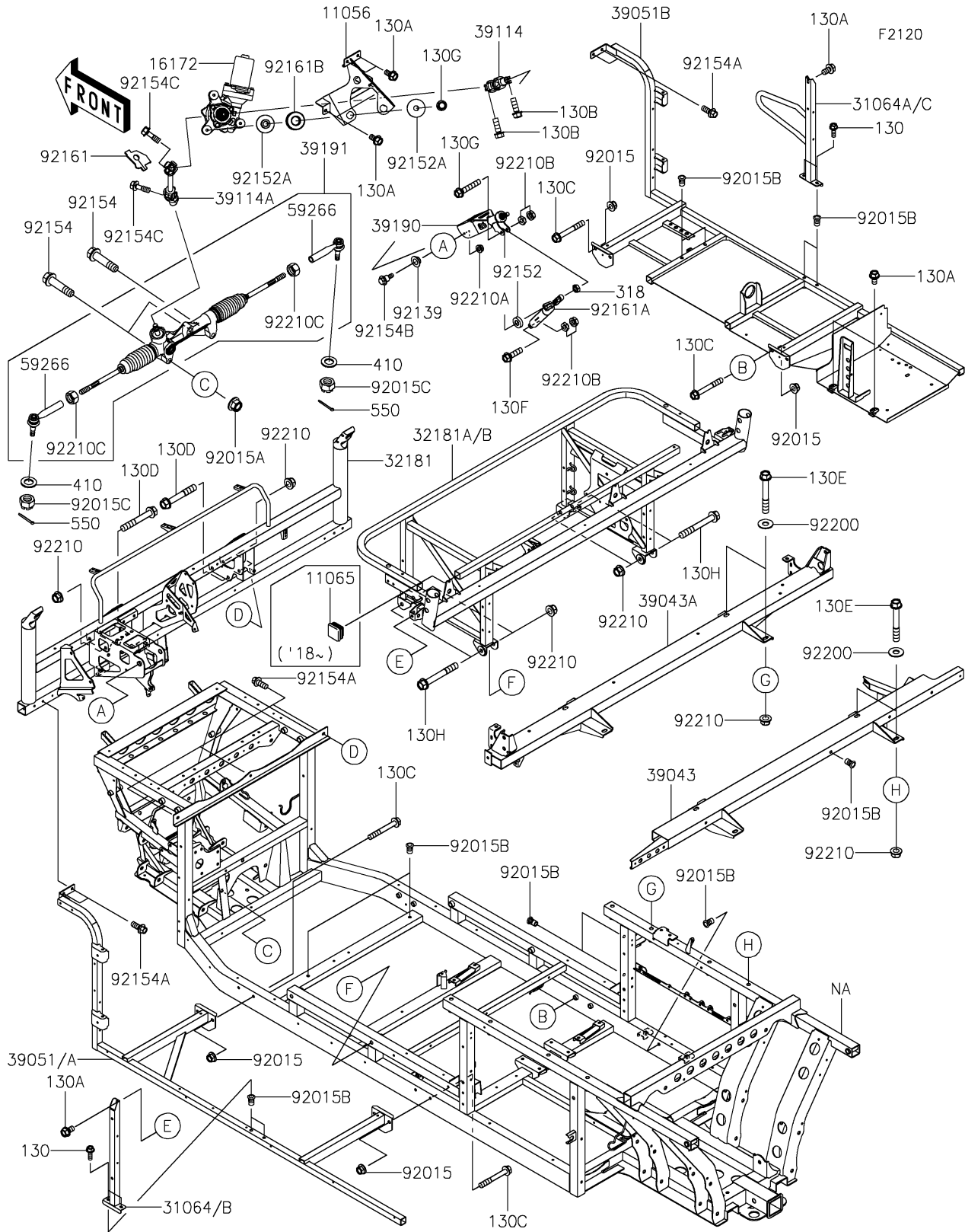

# 2018 MULE PRO-DX™ EPS DIESEL



## PARTS LIST

### Frame

ITEM NAME	PART NUMBER	QUANTITY
-----------	-------------	----------

---