

# 2020 KLX<sup>®</sup>150L

## PARTS DIAGRAM

### Ignition System

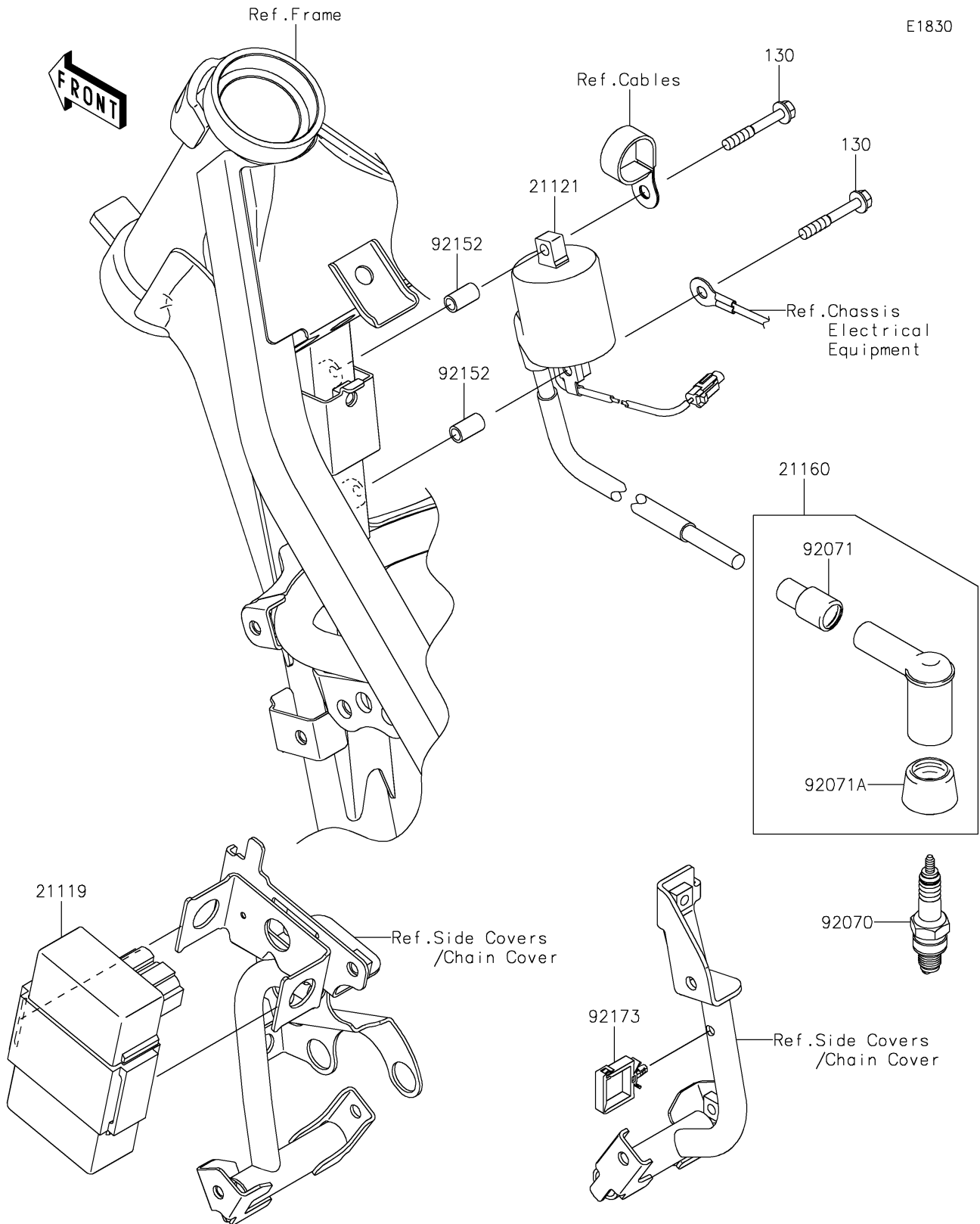

# 2020 KLX<sup>®</sup>150L

## PARTS LIST

### Ignition System

**ITEM NAME**

**PART NUMBER**

**QUANTITY**

---