

2007 Brute Force 750 4x4i

PARTS DIAGRAM

Engine Mount

F2122

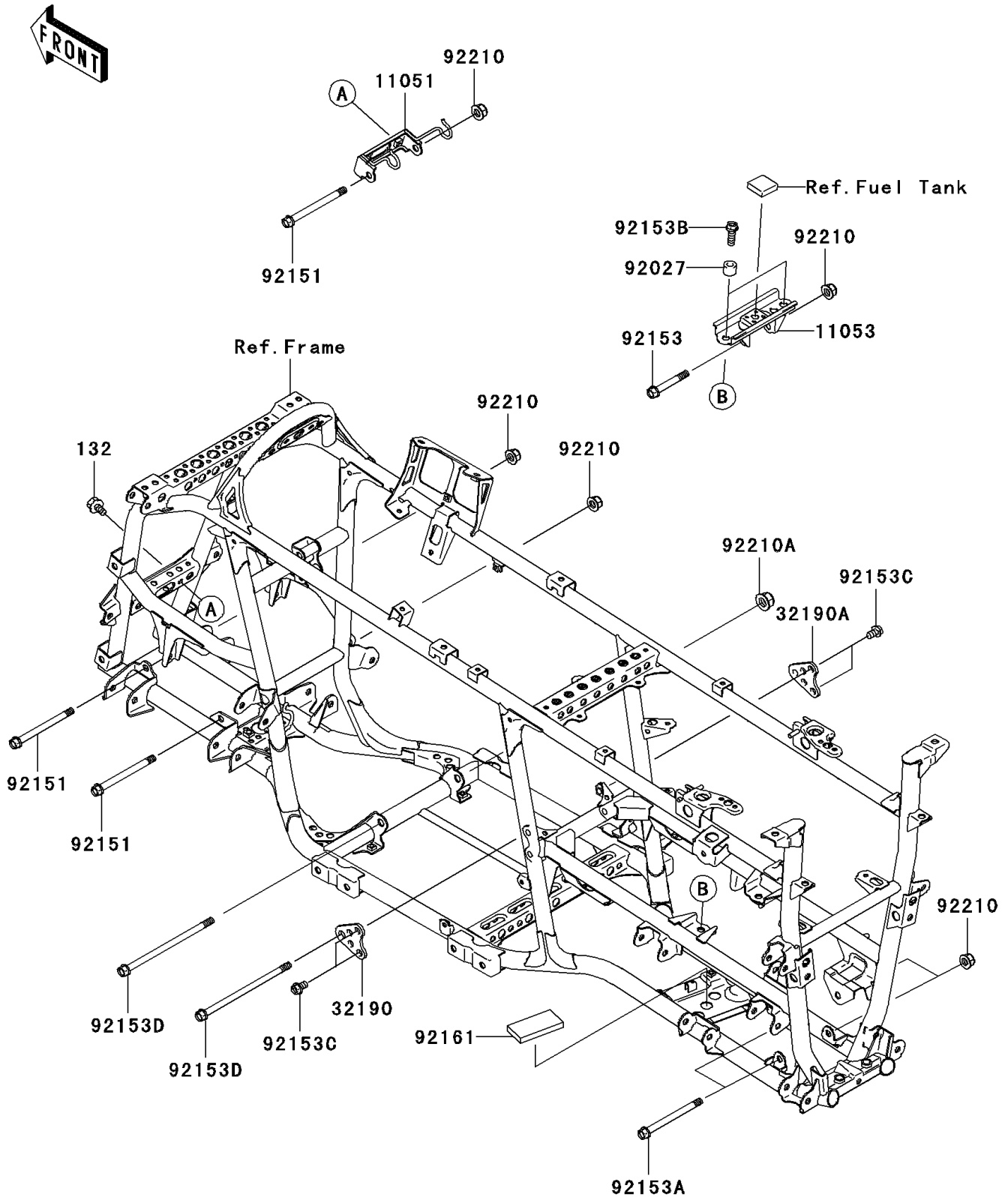

2007 Brute Force 750 4x4i

PARTS LIST

Engine Mount

ITEM NAME	PART NUMBER	QUANTITY
BOLT-FLANGED-SMALL,8X14 (Ref # 132)	132J0814	2
BRACKET,FRONT DIFF (Ref # 11051)	11051-1929	1
BRACKET,REAR DIFF,TOP (Ref # 11053)	11053-1592	1
BRACKET-ENGINE,RR,UPP,LH (Ref # 32190)	32190-0059	1
BRACKET-ENGINE,RR,UPP,RH (Ref # 32190A)	32190-0060	1
COLLAR,FRONT AXLE,L=14.5 (Ref # 92027)	92027-1472	2
BOLT,FLANGED,10X120 (Ref # 92151)	92151-1914	3
BOLT,FLANGED,M10X70 (Ref # 92153)	92153-0871	1
BOLT,FLANGED,10X120 (Ref # 92153A)	92153-0872	2
BOLT,FLANGED,10X30 (Ref # 92153B)	92153-0930	2
BOLT,FLANGED,10X16 (Ref # 92153C)	92153-0991	4
BOLT,FLANGED,12X190 (Ref # 92153D)	92153-1502	2
DAMPER (Ref # 92161)	92161-0215	1
NUT,LOCK,FLANGED,10MM (Ref # 92210)	92210-1081	6
NUT,LOCK,FLANGED,12MM (Ref # 92210A)	92210-1150	1