

# 2019 VULCAN® S

## PARTS DIAGRAM

### Brake Pedal/Torque Link

F2260

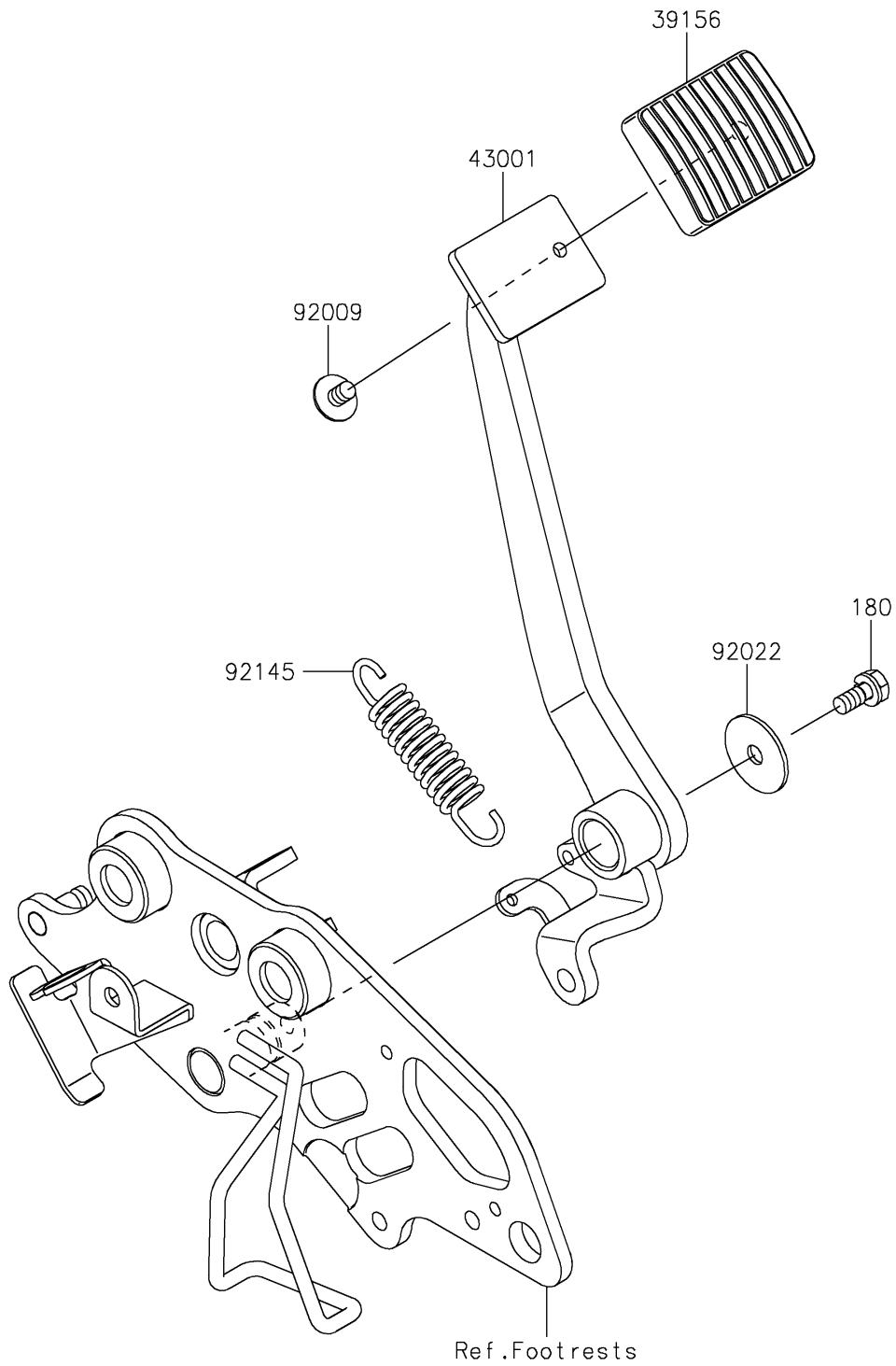

# 2019 VULCAN® S

## PARTS LIST

### Brake Pedal/Torque Link

**ITEM NAME**

**PART NUMBER**

**QUANTITY**

---