

# 2020 JET SKI® ULTRA® LX

## PARTS DIAGRAM

### Throttle

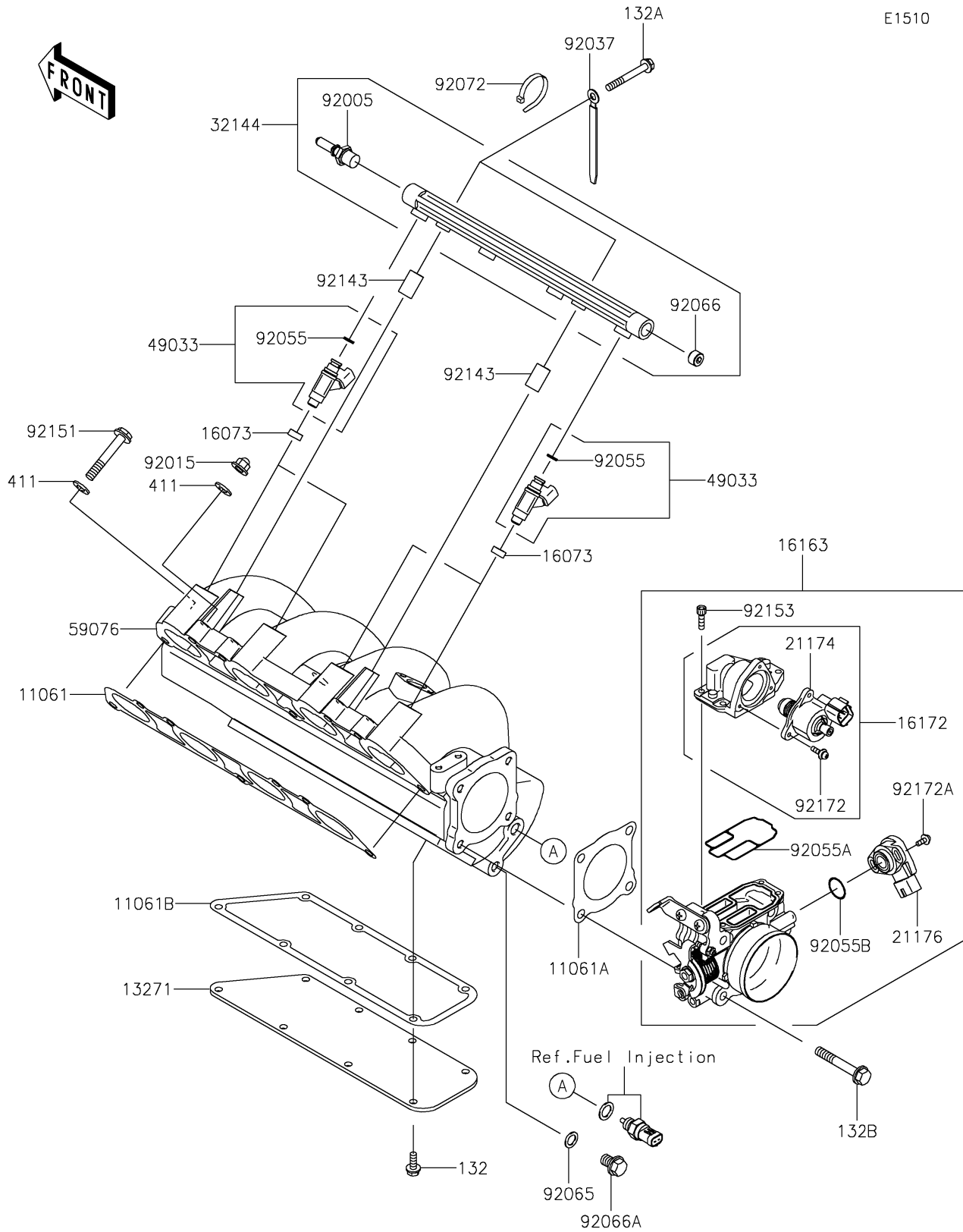

# 2020 JET SKI® ULTRA® LX

## PARTS LIST

### Throttle

**ITEM NAME**

**PART NUMBER**

**QUANTITY**

---