

# 2019 KX™100

## PARTS DIAGRAM

### Labels

F2860

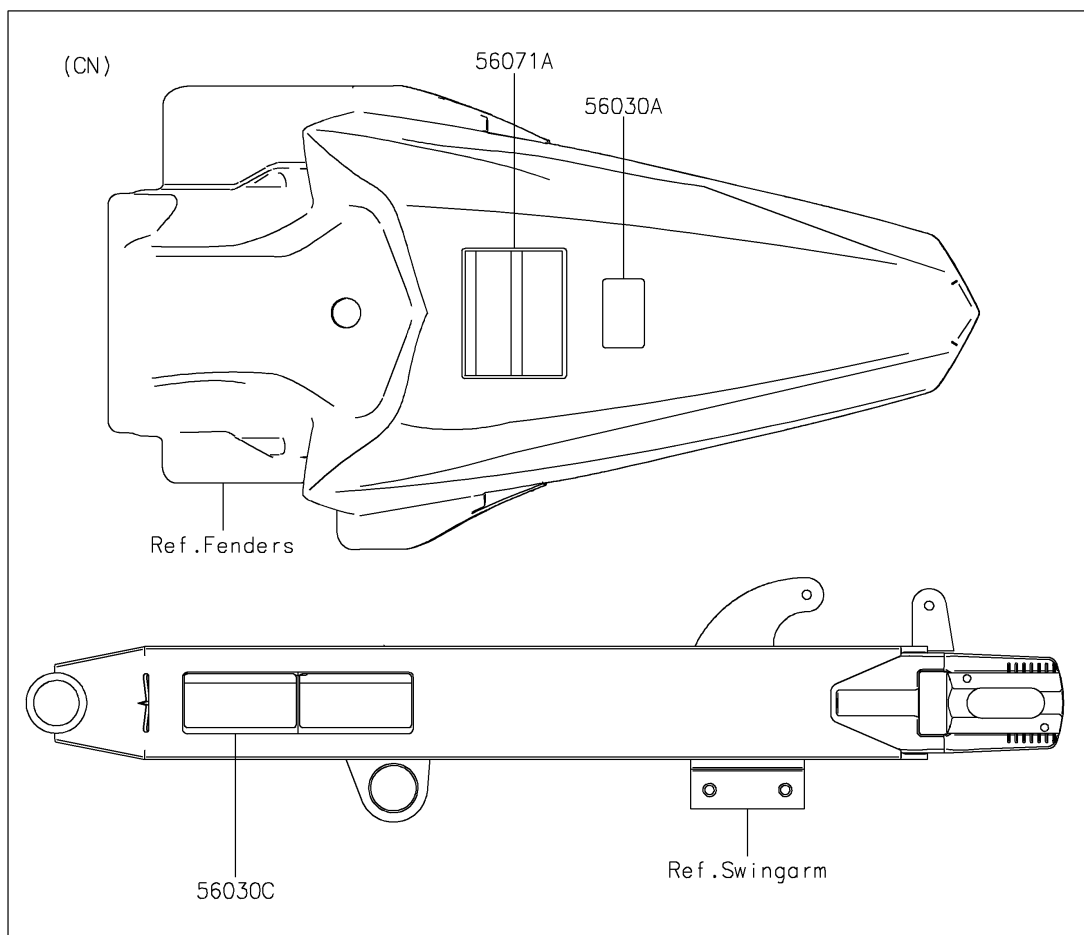
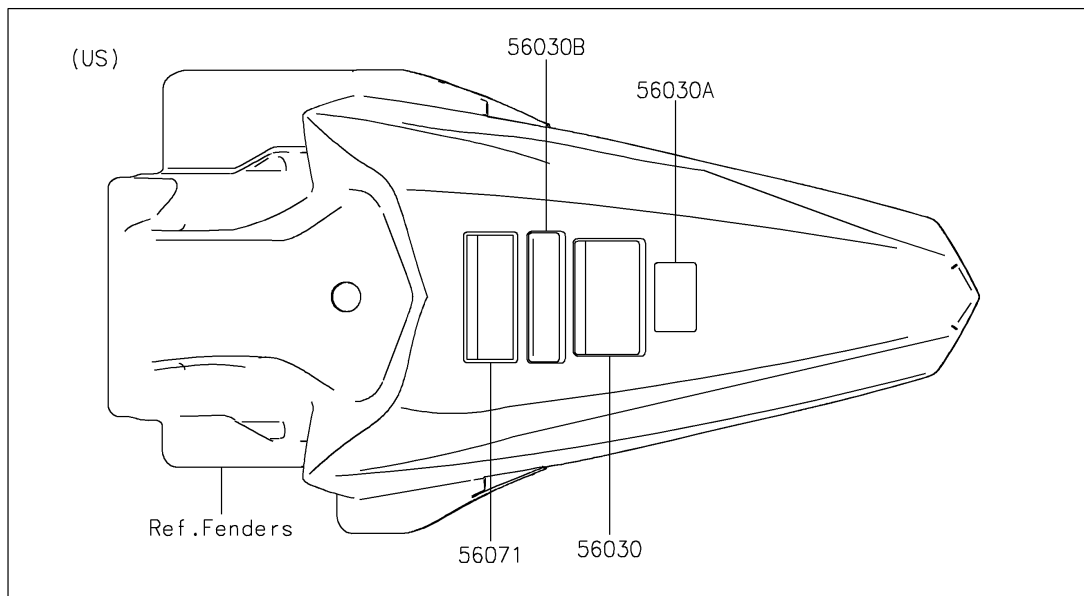

# 2019 KX™100

## PARTS LIST

### Labels

**ITEM NAME**

**PART NUMBER**

**QUANTITY**

---