

# 2019 Z125 PRO

## PARTS DIAGRAM

Meter(s)

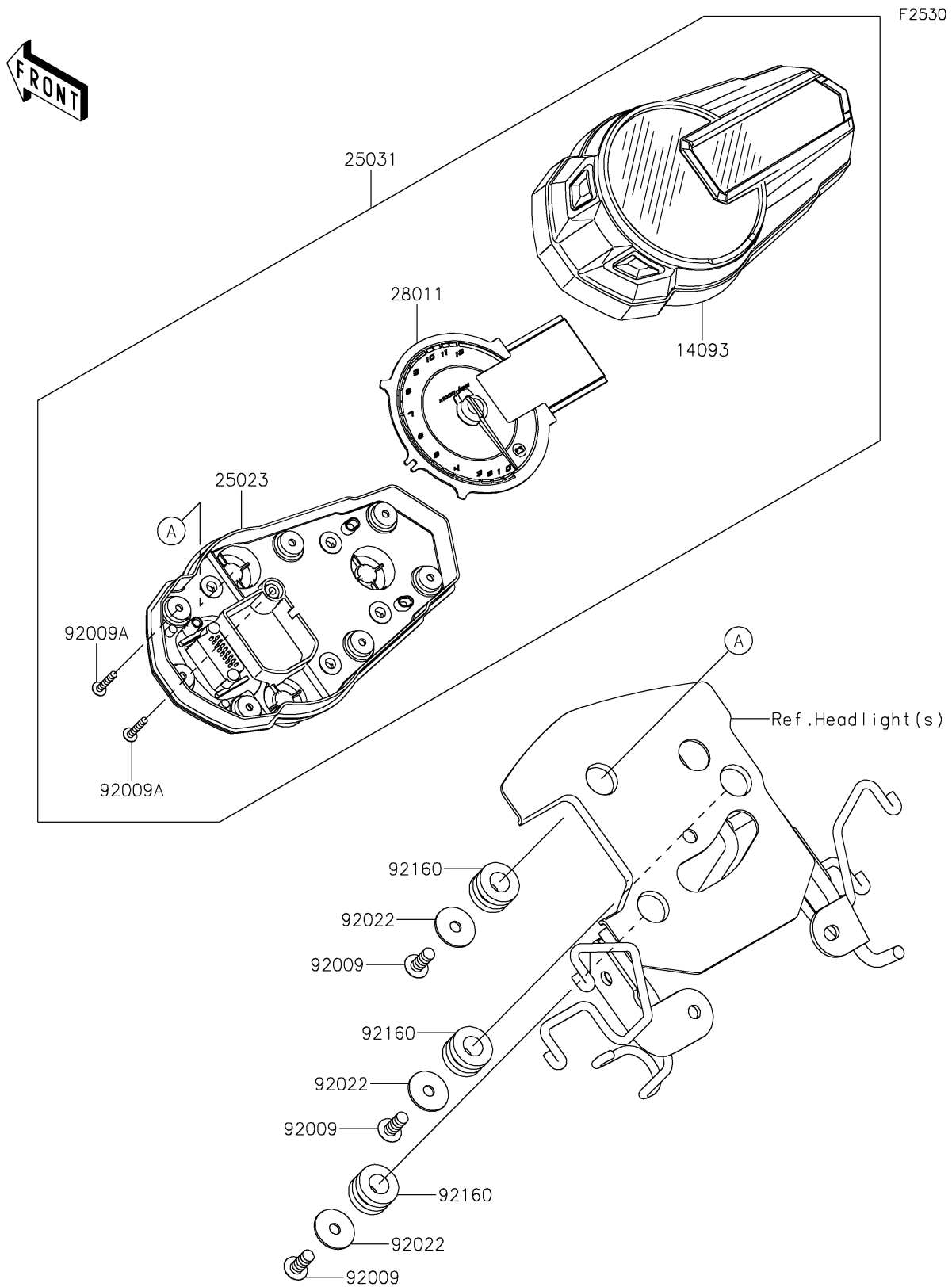

# 2019 Z125 PRO

## PARTS LIST

Meter(s)

**ITEM NAME**

**PART NUMBER**

**QUANTITY**

---