

2019 CONCOURS®14 ABS

PARTS DIAGRAM

Frame Fittings

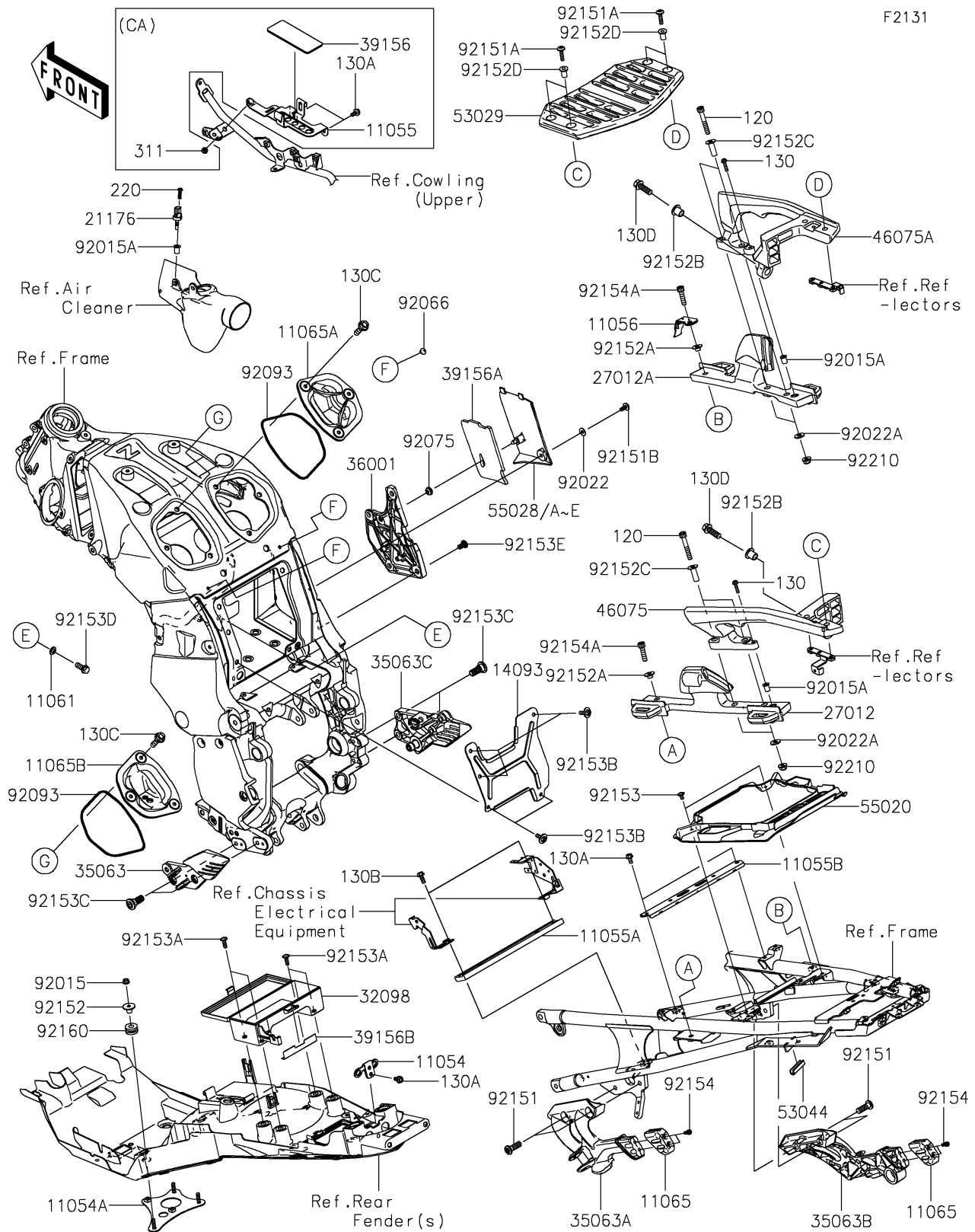

2019 CONCOURS®14 ABS

PARTS LIST Frame Fittings

ITEM NAME	PART NUMBER	QUANTITY
-----------	-------------	----------
