

2019 CONCOURS®14 ABS

PARTS DIAGRAM

Generator

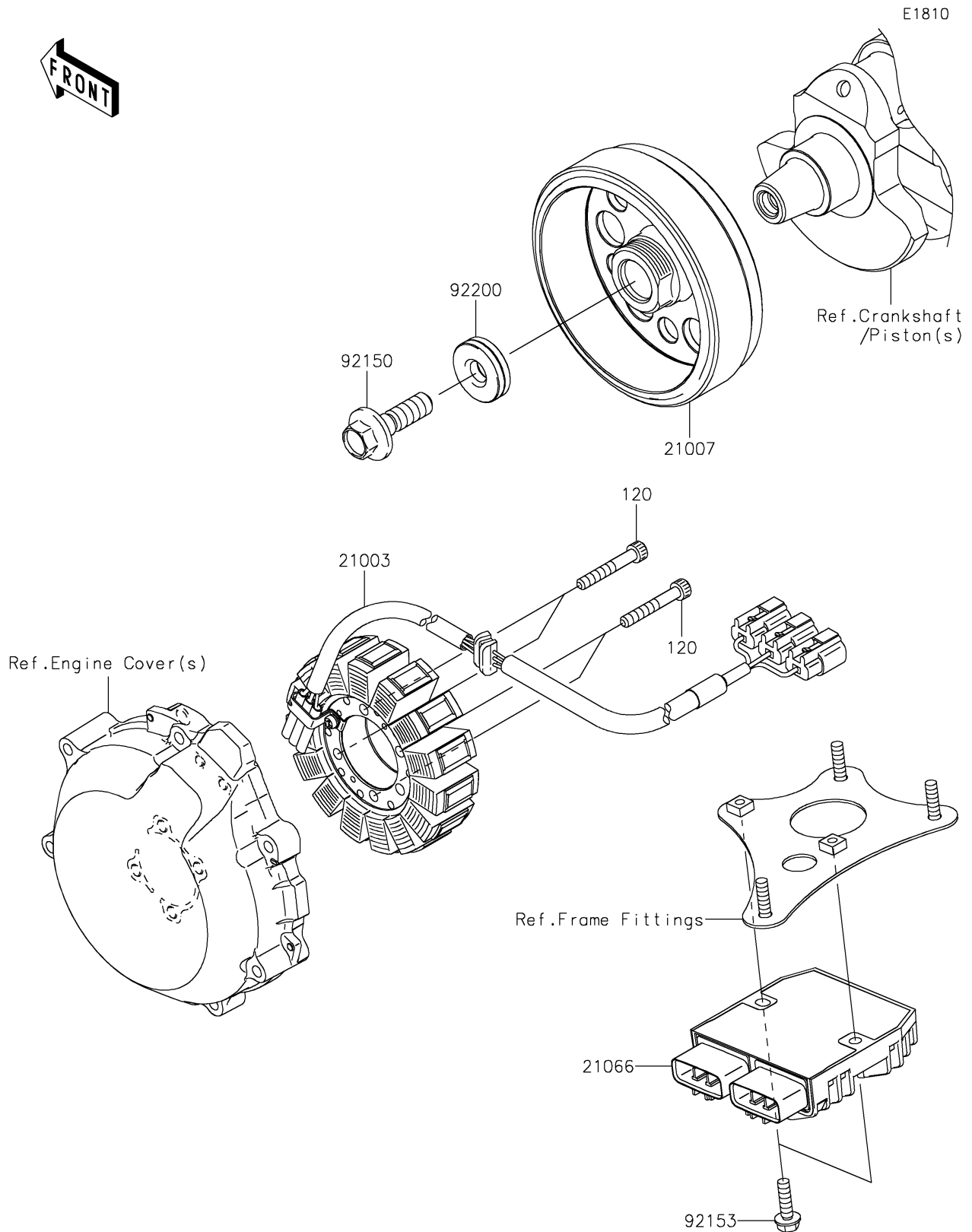

2019 CONCOURS®14 ABS

PARTS LIST

Generator

ITEM NAME

PART NUMBER

QUANTITY
