

2018 CONCOURS® 14 ABS

PARTS DIAGRAM

Crankcase

E1411

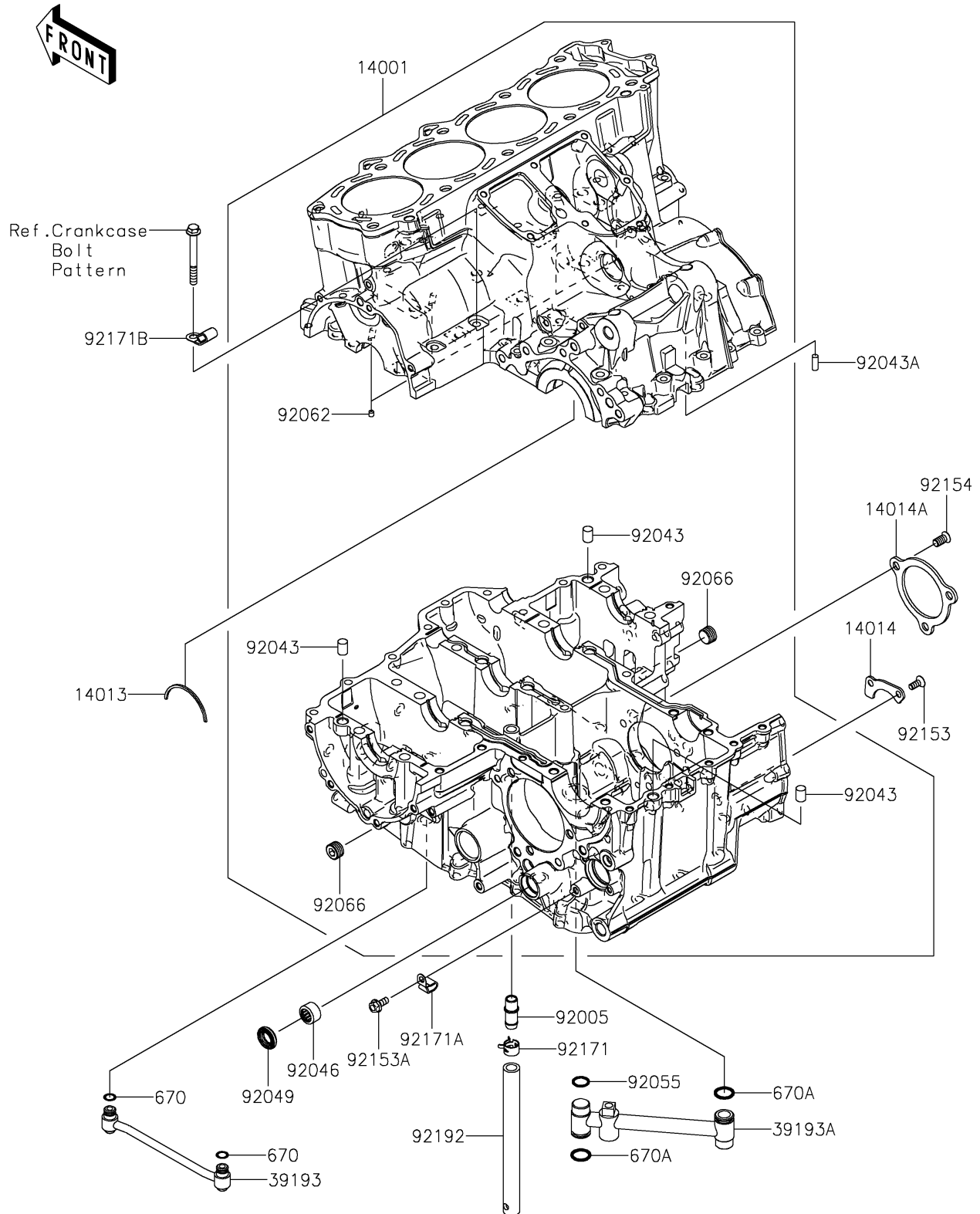

2018 CONCOURS®14 ABS

PARTS LIST

Crankcase

ITEM NAME

PART NUMBER

QUANTITY
