

# 2002 Prairie 300

## PARTS DIAGRAM

Carrier(s)

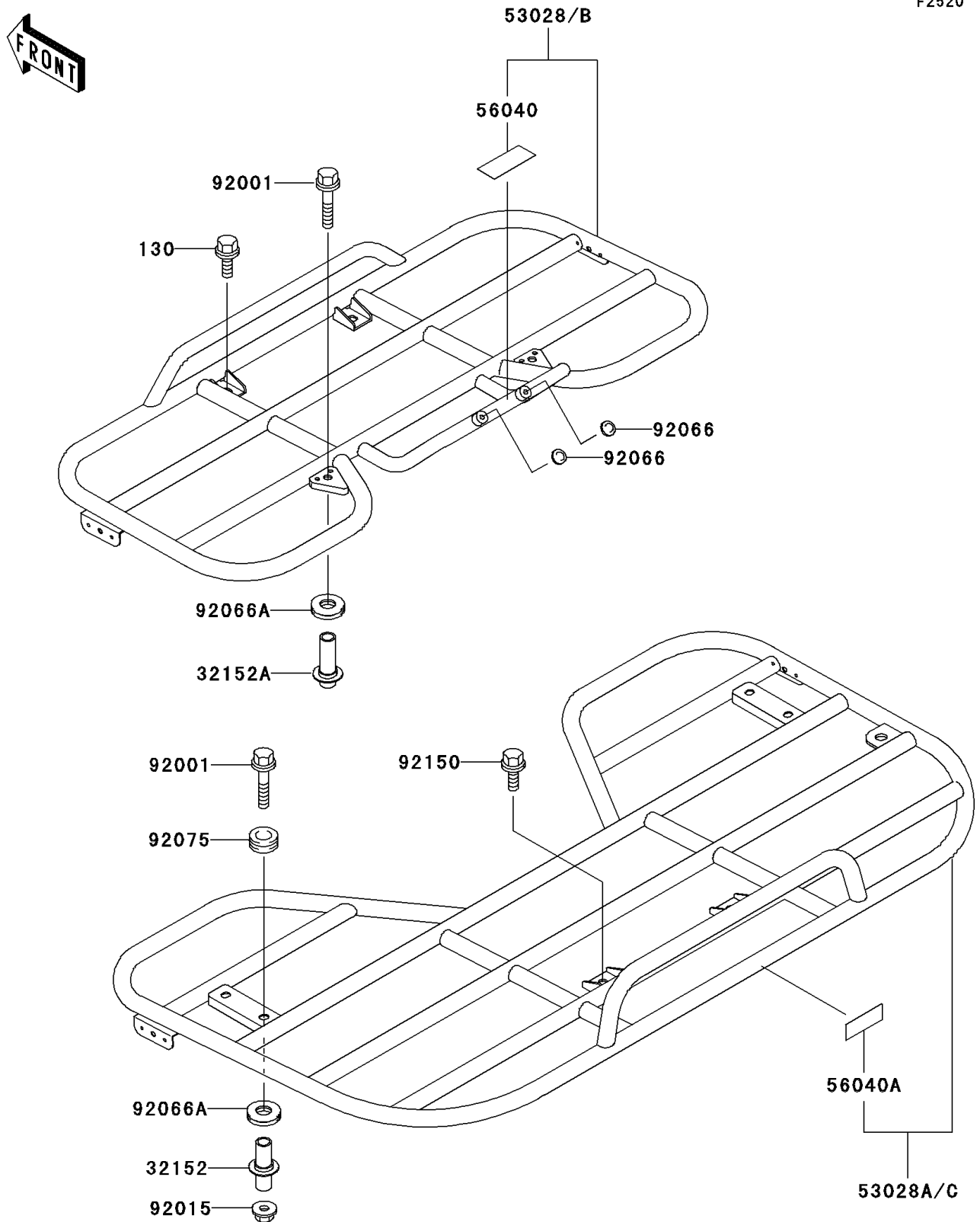

# 2002 Prairie 300

## PARTS LIST

Carrier(s)

**ITEM NAME**

**PART NUMBER**

**QUANTITY**

---