

# 2018 BRUTE FORCE® 750 4x4i EPS

## PARTS DIAGRAM

### Carrier(s)

F2520

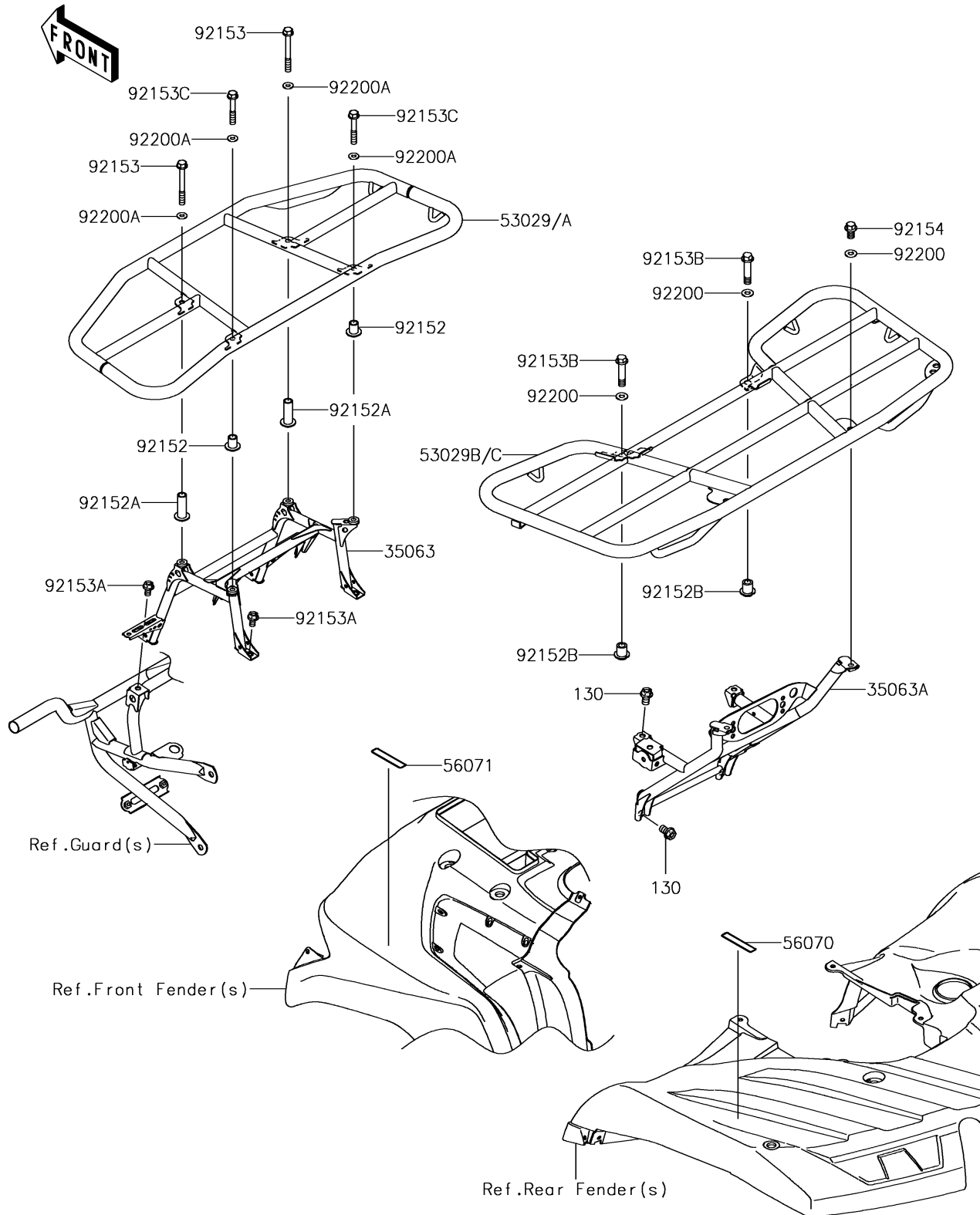

# 2018 BRUTE FORCE® 750 4x4i EPS



## PARTS LIST

Carrier(s)

ITEM NAME	PART NUMBER	QUANTITY
-----------	-------------	----------

---