

# 2015 JET SKI® ULTRA® 310X SE

## PARTS DIAGRAM

### Labels

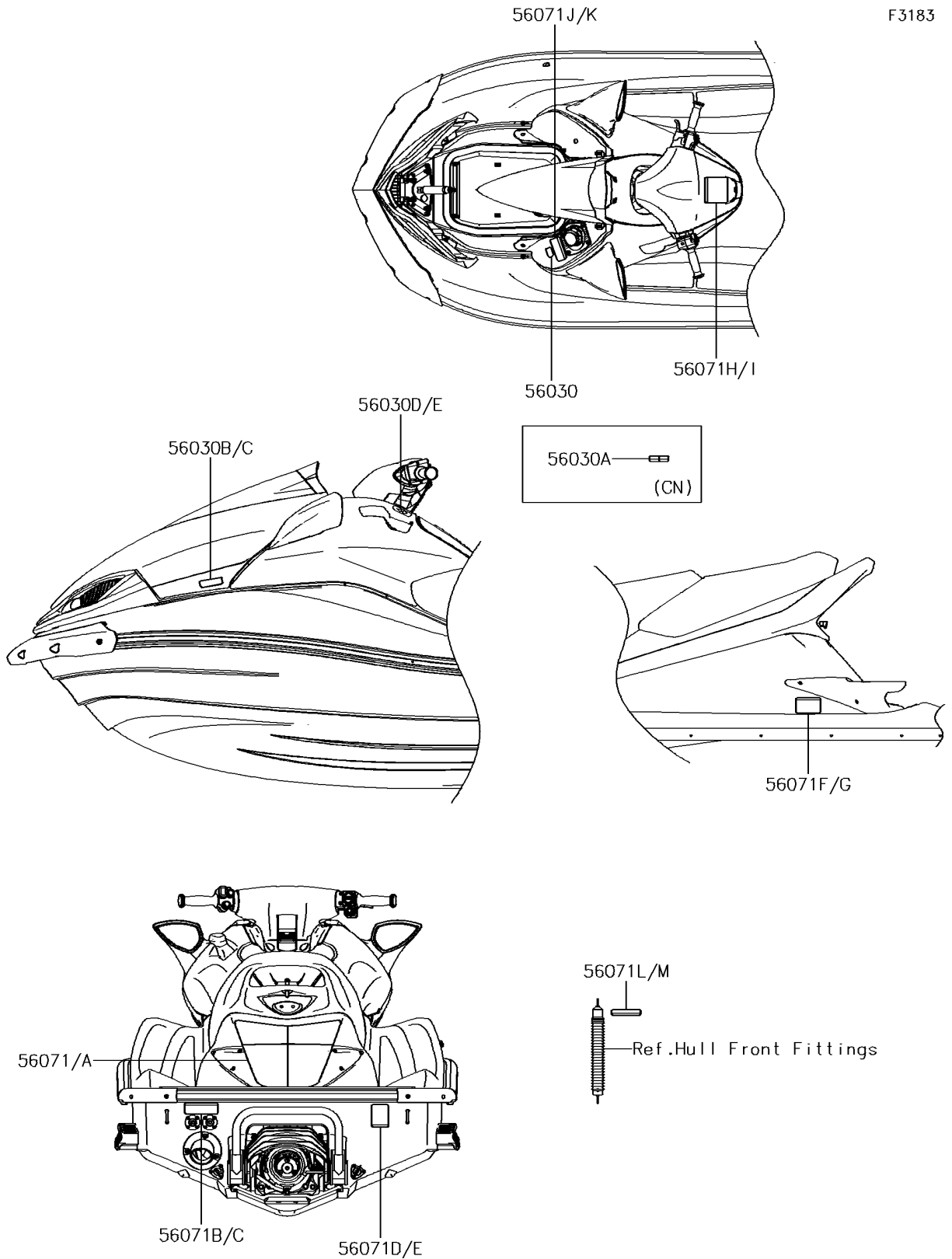

# 2015 JET SKI® ULTRA® 310X SE

## PARTS LIST

### Labels



**ITEM NAME**

**PART NUMBER**

**QUANTITY**

---