

# 2014 JET SKI® ULTRA® 310X SE

## PARTS DIAGRAM

### Meters

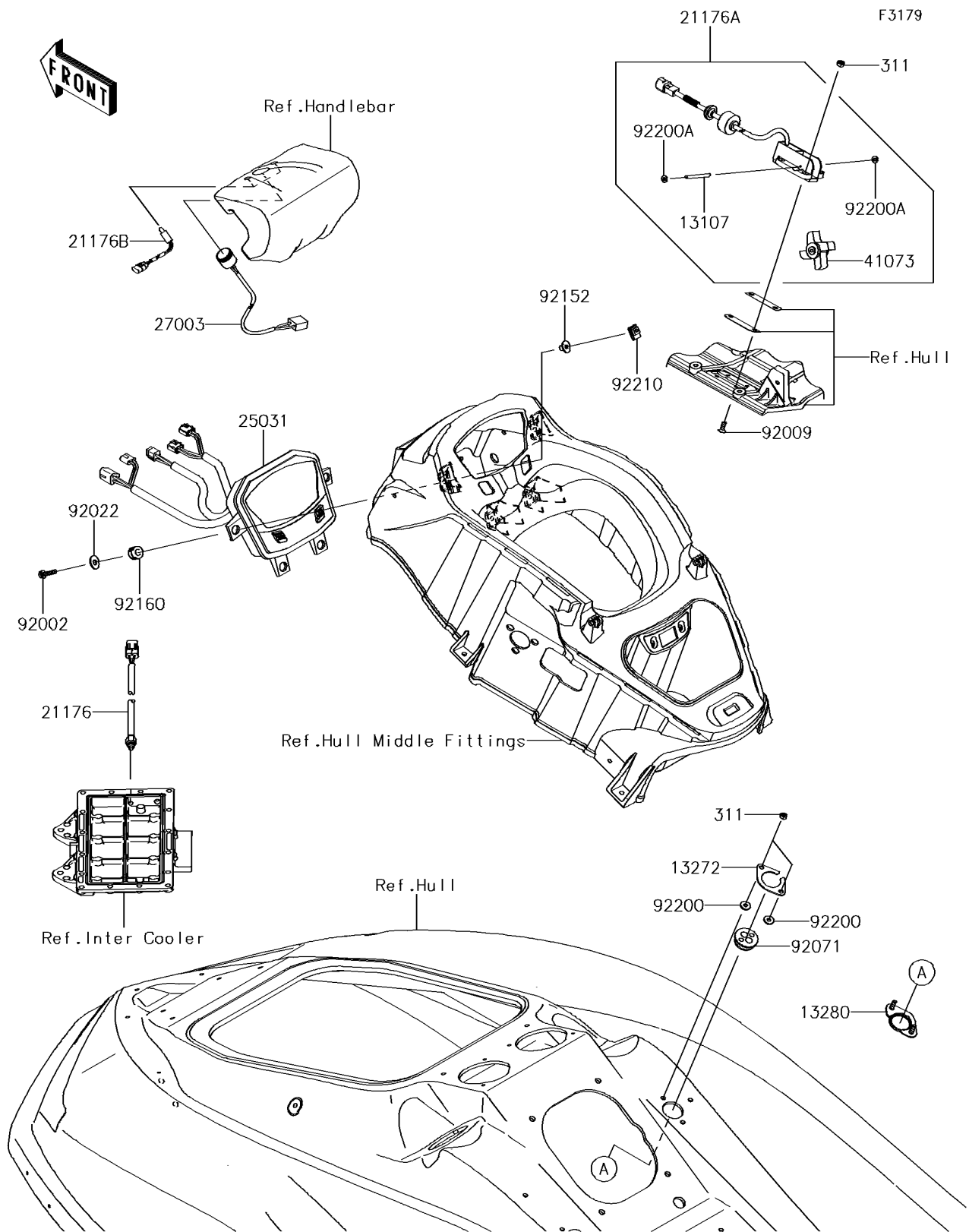

# 2014 JET SKI® ULTRA® 310X SE

## PARTS LIST

Meters



**ITEM NAME**

**PART NUMBER**

**QUANTITY**

---