

# 2015 JET SKI® ULTRA® 310X SE

## PARTS DIAGRAM

### Crankcase

E1411

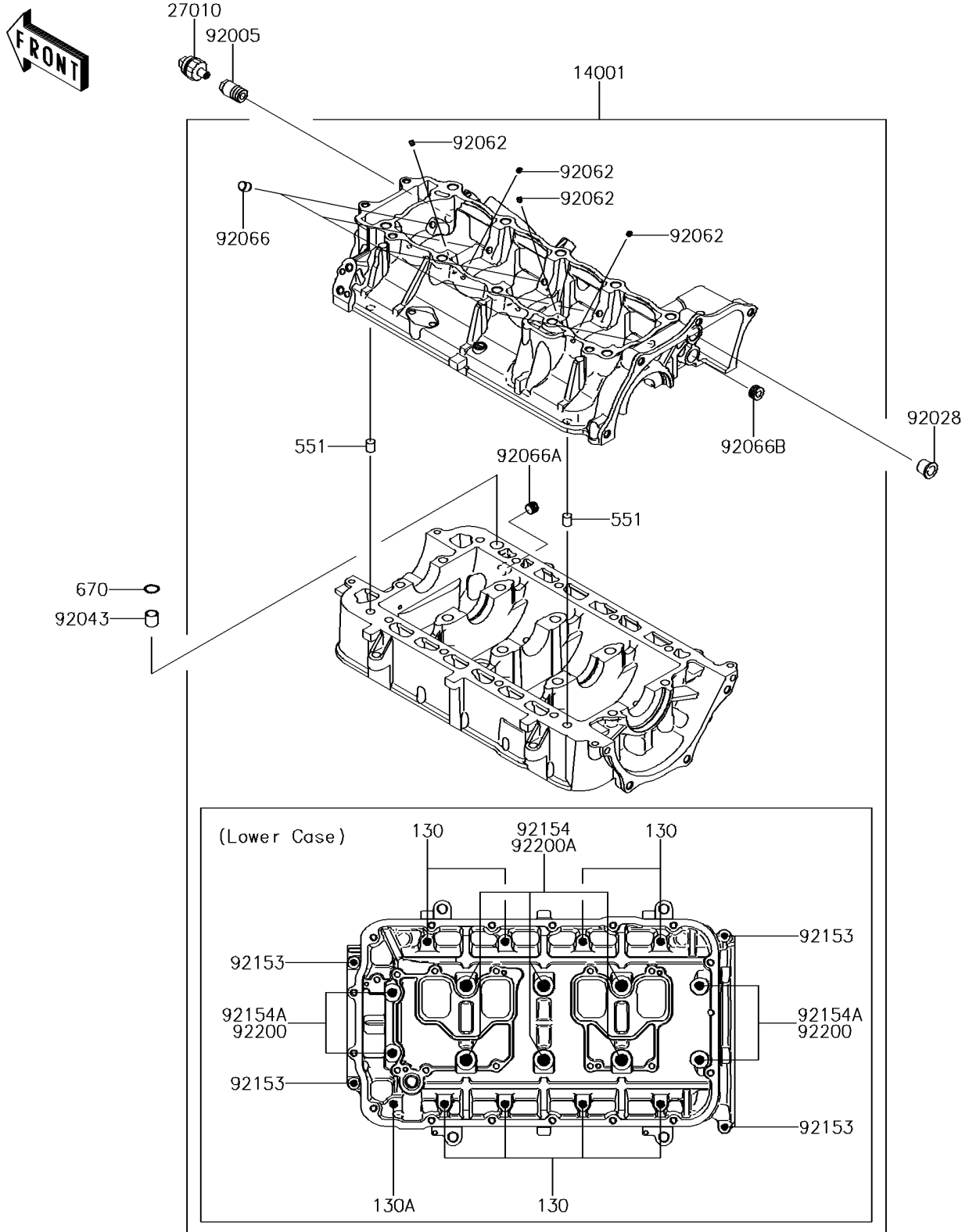

# 2015 JET SKI® ULTRA® 310X SE

## PARTS LIST

### Crankcase

**ITEM NAME**

**PART NUMBER**

**QUANTITY**

---