

# 2018 NINJA® ZX™-10R ABS

## PARTS DIAGRAM

### Rear Wheel/Chain

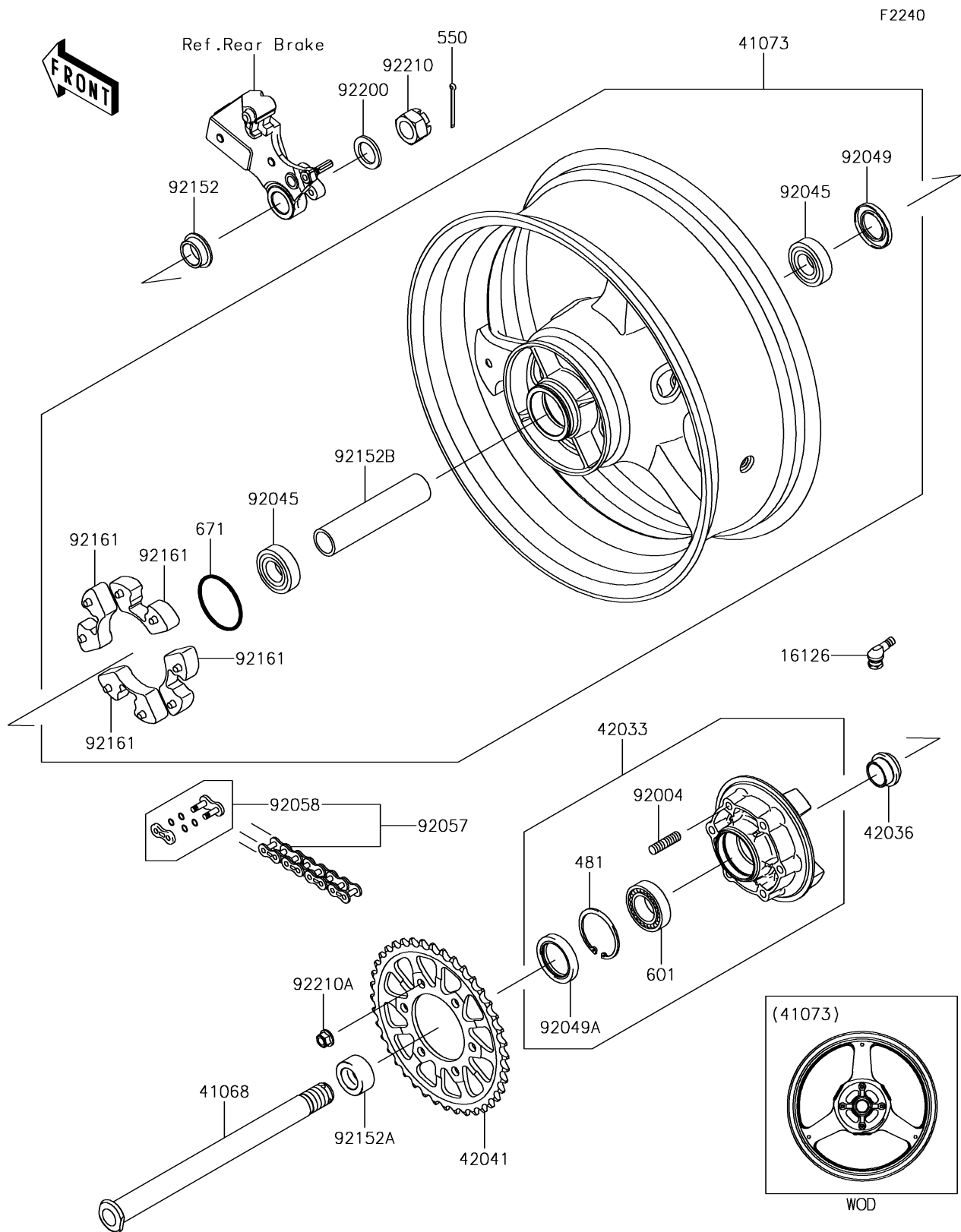

# 2018 NINJA® ZX™-10R ABS

## PARTS LIST

### Rear Wheel/Chain

ITEM NAME	PART NUMBER	QUANTITY
-----------	-------------	----------

---