

1996 KLX650

PARTS DIAGRAM

Water Pump

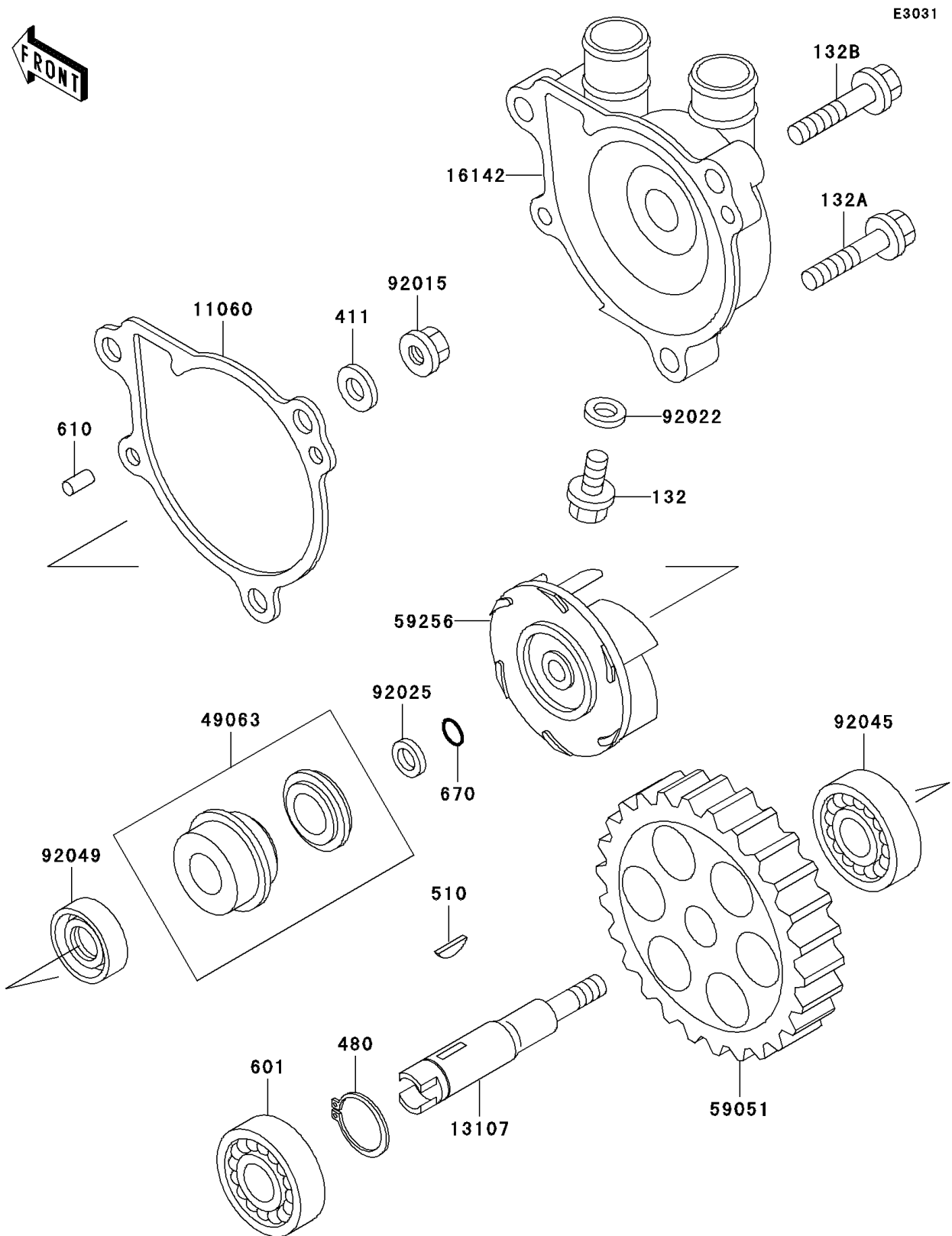

1996 KLX650

PARTS LIST

Water Pump

ITEM NAME	PART NUMBER	QUANTITY
BOLT-FLANGED-SMALL (Ref # 132)	132Y0608	1
BOLT-FLANGED-SMALL (Ref # 132A)	132Y0630	2
BOLT-FLANGED-SMALL (Ref # 132B)	132Y0635	1
WASHER-PLAIN,6MM,BLACK (Ref # 411)	411F0600	1
CIRCLIP-TYPE-C,12MM (Ref # 480)	480J1200	1
KEY-WOODRUFF (Ref # 510)	510A3100	1
BEARING-BALL (Ref # 601)	601A6001	1
ROLLER,4X8 (Ref # 610)	610A0408	2
O RING,6MM (Ref # 670)	670B1506	1
GASKET,WATER PUMP COVER (Ref # 11060)	11060-1114	1
SHAFT,WATER PUMP (Ref # 13107)	13107-1305	1
COVER-PUMP (Ref # 16142)	16142-1122	1
SEAL-MECHANICAL (Ref # 49063)	49063-1054	1
GEAR-SPUR,37T (Ref # 59051)	59051-1284	1
IMPELLER (Ref # 59256)	59256-1055	1
NUT,FLANGED,6MM (Ref # 92015)	92015-1078	1
WASHER,6.2X11X1 (Ref # 92022)	92022-304	1
SHIM,T=0.8 (Ref # 92025)	92025-1503	1
BEARING-BALL,6901 (Ref # 92045)	92045-1246	1
SEAL-OIL,AC037AE0 (Ref # 92049)	92049-1228	1