

# 2011 NINJA® ZX™-6R

## PARTS DIAGRAM

### Oil Pump/Oil Filter

E1710

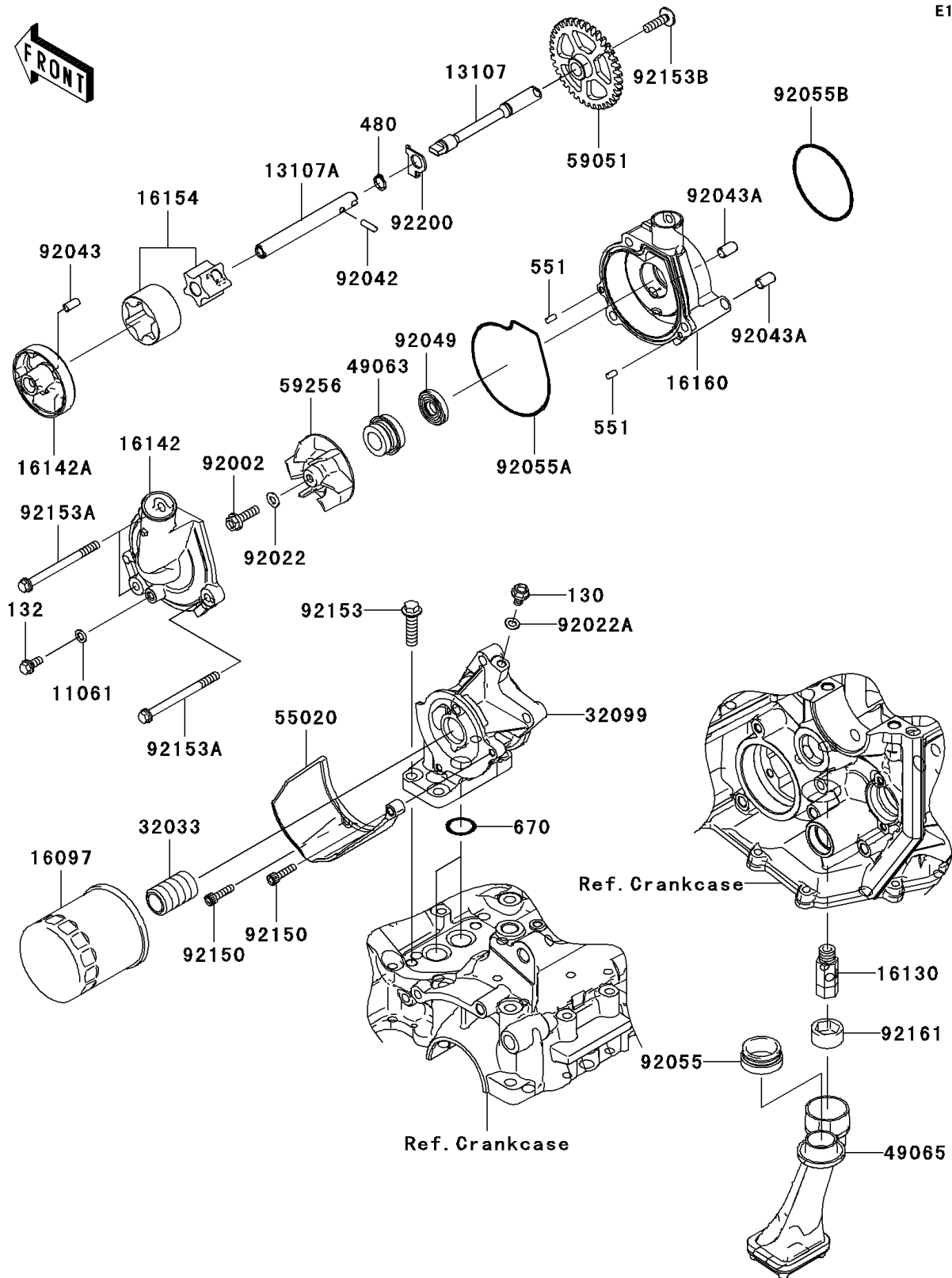

# 2011 NINJA® ZX™-6R

## PARTS LIST

### Oil Pump/Oil Filter

**ITEM NAME**

**PART NUMBER**

**QUANTITY**

---