

1998 Bayou 400 4X4

PARTS DIAGRAM

Optional Parts(Meter)

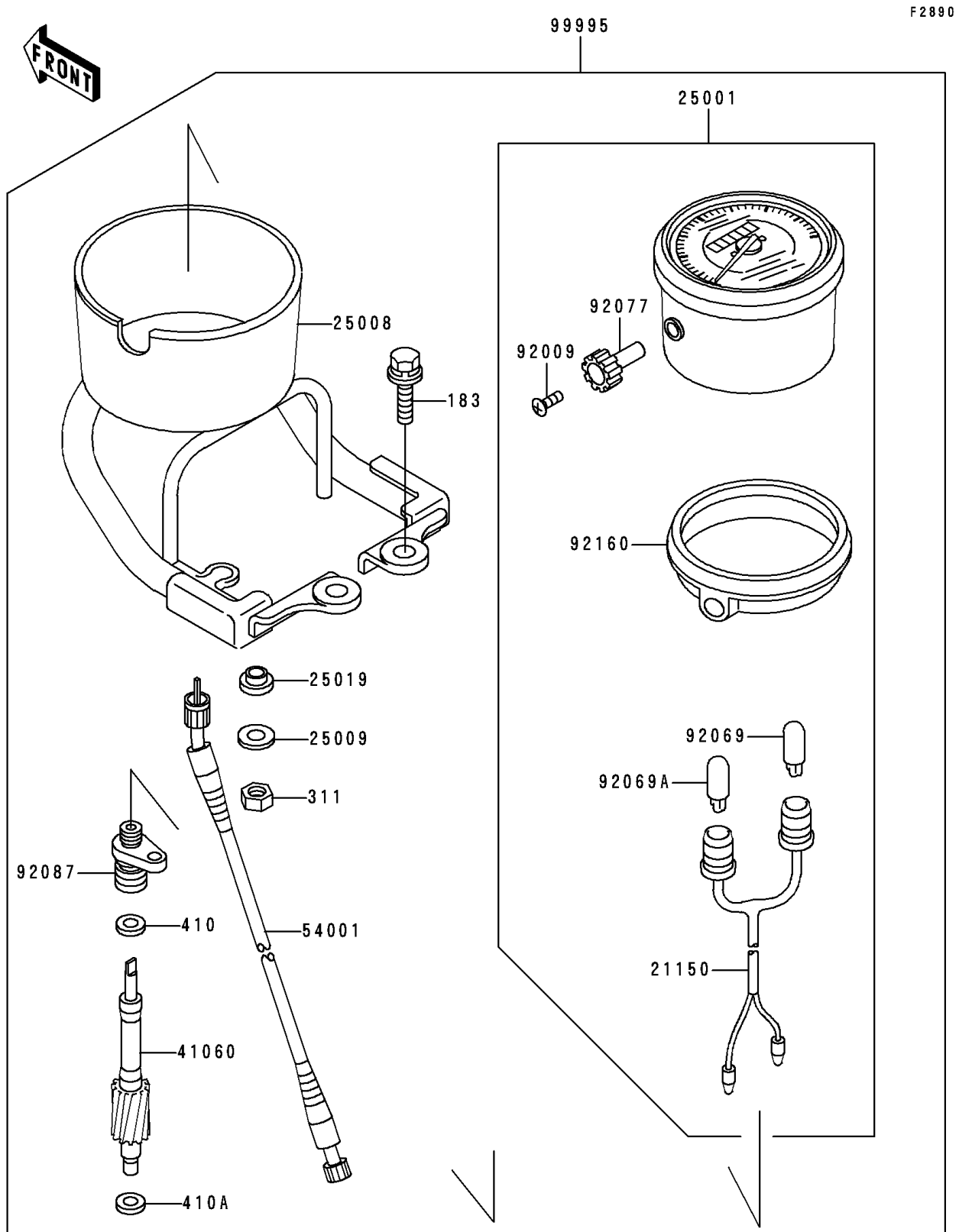

1998 Bayou 400 4X4

PARTS LIST

Optional Parts(Meter)

ITEM NAME

PART NUMBER

QUANTITY
