

# 1994 Bayou 400 4X4

## PARTS DIAGRAM

### Owner's Tools

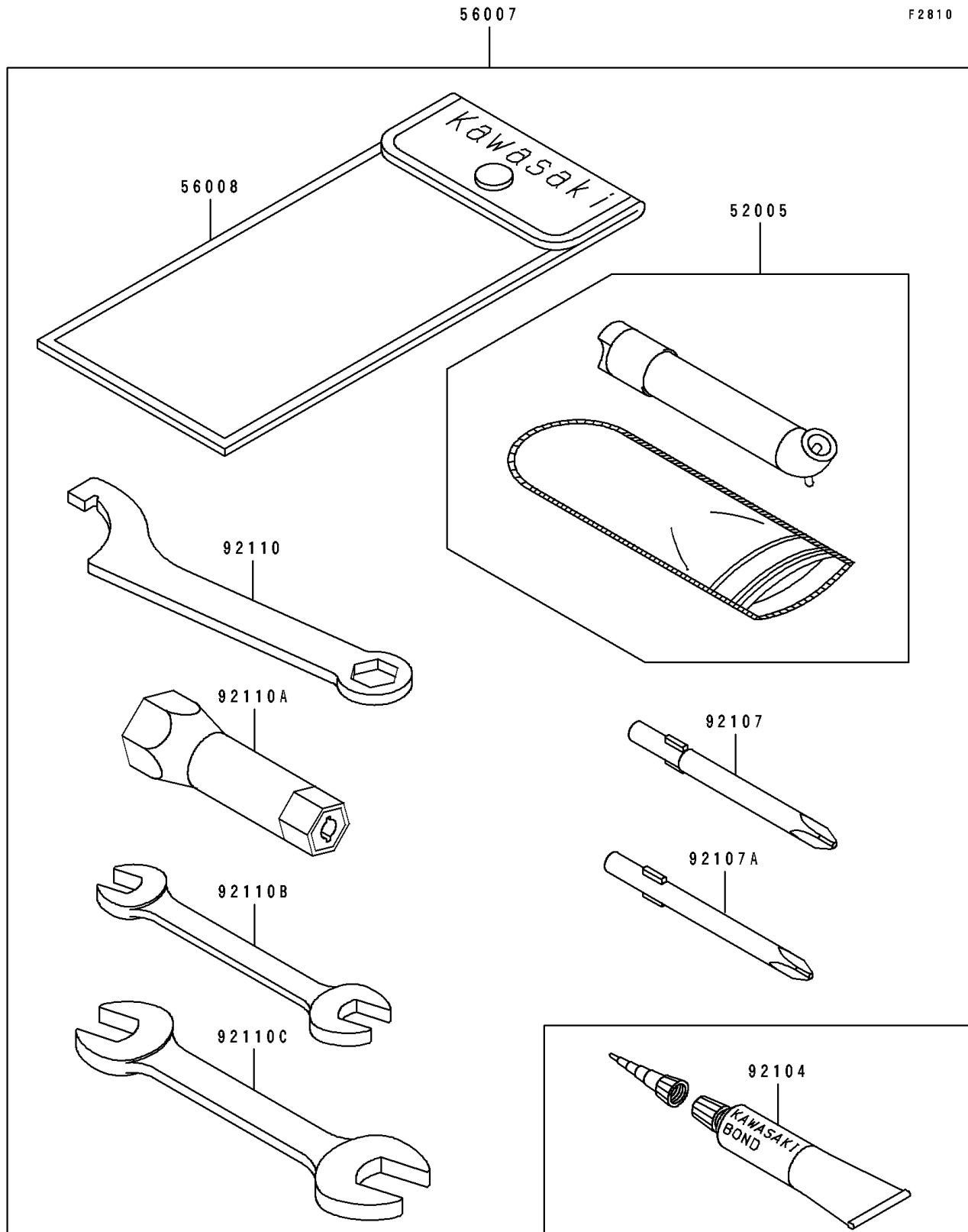

# 1994 Bayou 400 4X4

## PARTS LIST

### Owner's Tools

**ITEM NAME**

**PART NUMBER**

**QUANTITY**

---