

1999 Bayou 300 4X4

PARTS DIAGRAM

Optional Parts(Radiator)

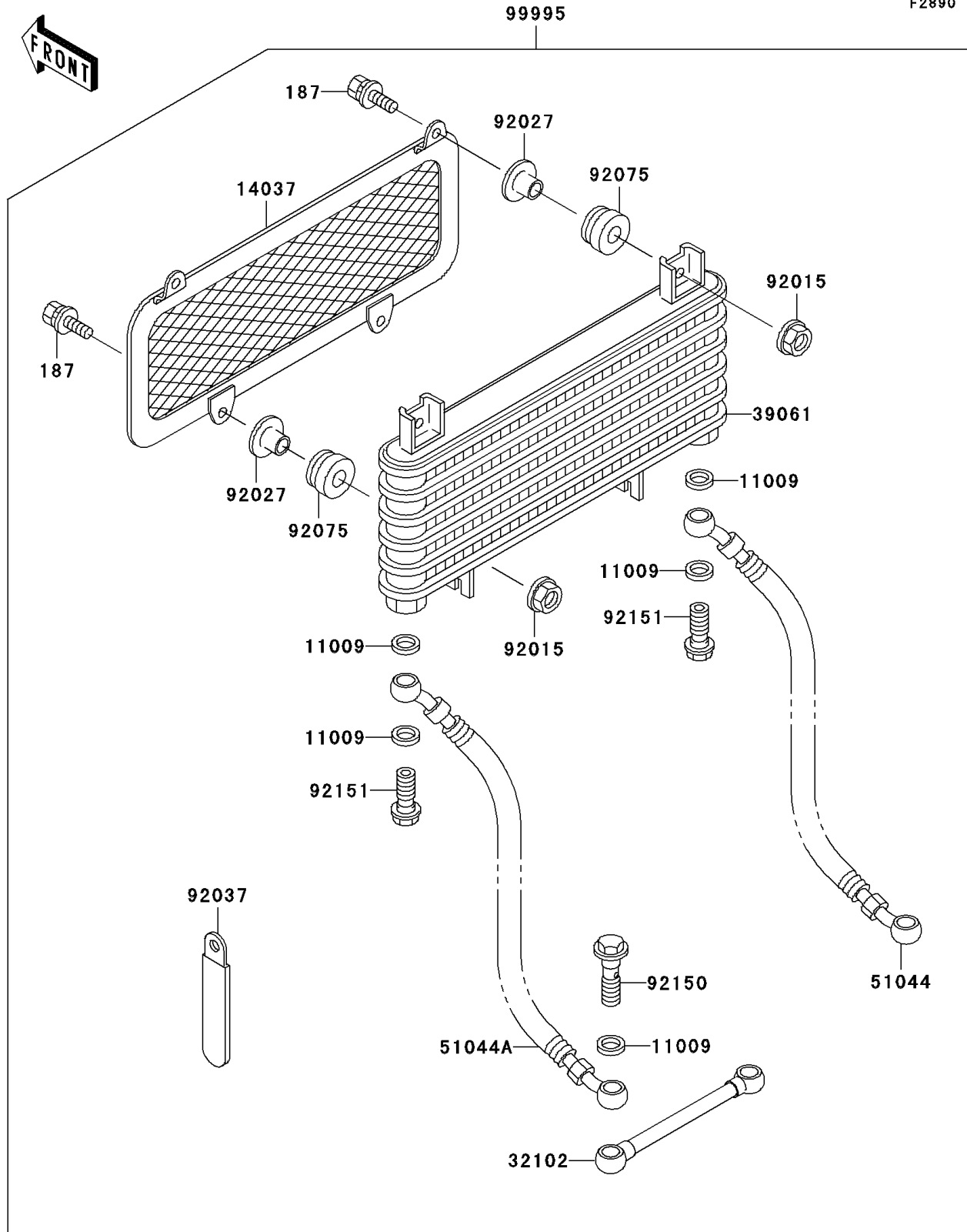

1999 Bayou 300 4X4

PARTS LIST

Optional Parts(Radiator)

ITEM NAME

PART NUMBER

QUANTITY
